

Defense Science Board Task Force

on

**HIGH ENERGY LASER
WEAPON SYSTEMS APPLICATIONS**



June 2001

**Office of the Under Secretary of Defense
For Acquisition, Technology, and Logistics
Washington, D.C. 20301-3140**

This report is a product of the Defense Science Board (DSB). The DSB is a Federal Advisory Committee established to provide independent advice to the Secretary of Defense. Statements, opinions, conclusions, and recommendations in this report do not necessarily represent the official position of the Department of Defense.

This report is unclassified.



DEFENSE SCIENCE
BOARD

OFFICE OF THE SECRETARY OF DEFENSE
WASHINGTON, D.C. 20301-3140

15 Aug 01

MEMORANDUM FOR UNDER SECRETARY OF DEFENSE (ACQUISITION, TECHNOLOGY
& LOGISTICS)

SUBJECT: Final Report of the Defense Science Board (DSB) Summer Study Task Force on
High Energy Laser Weapon System Applications

I am pleased to forward the final report of the DSB Task Force on High Energy Laser (HEL) Weapon System Applications. The Task Force was tasked to review and evaluate recent and on-going programs in HEL applications, examine recent supporting technology advancements and their applications, and determine what remains to be done to "weaponize" these systems in applicable combat theater environments. They were asked to make recommendations on the need for additional DoD research efforts, strategic and tactical impact of HEL systems on future military operations, and capabilities of the U.S. defense industrial base to support development of HEL systems.

In their report, the Task Force states that high power lasers have the potential to change future military operations in dramatic ways. The United States is in a position to exploit current high energy laser technology to take advantage of speed-of-light engagement, precisely controlled effects, deep magazines, low cost per shot, and reduced logistics footprint.

To that end, I agree with the report's findings that the development of High Energy Laser systems deserve a sustained, department-wide science and technology investment in basic and exploratory research in order to improve reliability and reduce the cost of HEL systems, especially for tactical applications.

I endorse all of the Task Force's recommendations and propose you review the Task Force Chairman's letter and report.

A handwritten signature in black ink that reads "William Schneider, Jr." with a stylized flourish at the end.

Dr. William Schneider, Jr.



DEFENSE SCIENCE
BOARD

OFFICE OF THE SECRETARY OF DEFENSE
3140 DEFENSE PENTAGON
WASHINGTON, DC 20301-3140

August 2, 2001

MEMORANDUM FOR THE CHAIRMAN, DEFENSE SCIENCE BOARD

Subject: Final Report of the Defense Science Board Task Force on High Energy Laser
Weapon System Applications

High-energy laser (HEL) systems provide the Department of Defense with unique opportunities to augment and improve its operational capabilities and tactics in a variety of mission areas. The potential for speed-of-light engagement, unique damage mechanisms, greatly enhanced multi-target engagement, and deep magazines suggest a new level of flexibility and adaptability, attributes that are particularly valuable in the complex national security environment currently existing and unfolding.

In order for the Department to effectively incorporate HEL weapon systems into warfighting operations at the earliest possible opportunity, our task force was asked to review the Department's ongoing initiatives in high-energy laser applications, including supporting technology programs. As part of our effort, we were asked to examine the major issues confronting the development of HEL technologies and their transition into operational systems.

Based on our review of ongoing and potential activities in high-energy laser research and development, the task force reached the following conclusions:

- High-energy laser technologies have matured to the point that a family of applications is feasible over the next two decades, to include systems on aircraft, space vehicles, ships, and ground vehicles.
- HEL systems are an area of technological advantage that can be exploited by the United States.
- HEL systems offer speed-of-light engagement of a variety of targets with the potential to produce a range of precisely controlled effects, as well as the potential of deep magazines, low cost per shot (or per kill), and reduced logistics footprint.
- There remain formidable science and technology tasks that must be addressed to realize the potential of high-energy lasers, to include work on a variety of laser sources, beam control, power generation and storage, thermal management, atmospheric understanding and compensation, and weapons effects.
- There are continuing engineering challenges to improve reliability and reduce the cost and size of HEL systems, especially for tactical applications.

- The United States has underfunded basic (6.1) and exploratory development (6.2) research on high-energy laser technologies.

The task force supports continued development of the HEL systems underway. Appropriately developed and applied, these systems can become key contributors to the 21st-century arsenal. Toward that end, the task force offers specific recommendations for improvements to the development path of each initiative, which you will find in the attached report.

However, our greatest concern and most important recommendation focus on the underlying science and technology program. The Department of Defense must develop a coherent, department-wide, prioritized technology program to support the growing family of potential HEL applications. Such a program will require a sustained investment of significantly more resources than currently in the budget. We believe the needed increase in funding is judged to be \$100-150 million per year. Without this investment, the potential of high-energy laser weapon systems is unlikely to be realized.

General/Larry D. Welch, USAF (Ret.)



Mr. Donald C. Latham

TABLE OF CONTENTS

EXECUTIVE SUMMARY.....	iii
CHAPTER 1. CURRENT INITIATIVES	1
Airborne Laser.....	4
Space Based Laser.....	13
High Energy Laser System – Tactical Army.....	31
CHAPTER 2. NEW APPLICATIONS	41
Advanced Tactical Laser.....	43
Ground Based Laser for Space Control.....	48
Evolutionary Aerospace Global Laser Engagement System.....	56
Tactical High Energy Laser Fighter.....	65
Future Combat System Applications.....	72
Countermunitions.....	83
Maritime Self-Defense	86
Large-Aircraft Self-Defense.....	89
Operations Other Than War	90
CHAPTER 3. MAJOR ISSUES	95
Atmospheric and Propagation Concerns.....	97
Understanding Effects and Vulnerability.....	105
Modeling and Simulation.....	111
Beam Control.....	115
Laser Development	122
CHAPTER 4. SCIENCE AND TECHNOLOGY NEEDS	131
High-Energy Laser Program Funding.....	133
S&T Program Philosophy	134
Targeting S&T Investment	136
CHAPTER 5. RECOMMENDATIONS	143
Appendix A. Terms of Reference	A-1
Appendix B. Task Force Membership	B-1
Appendix C. Briefings Received by the Task Force.....	C-1
Appendix D. Summary of the Directed Energy Applications for Tactical Airborne Combat Study.....	D-1
Appendix E. Free-Electron Lasers.....	E-1
Appendix F. Glossary of Acronyms and Abbreviations	F-1

EXECUTIVE SUMMARY

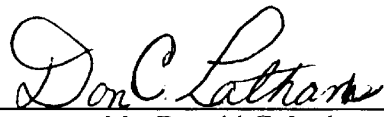
INTRODUCTION

Several decades of science and technology, concept development, and engineering development have provided the underpinnings for a significant contribution by high-energy lasers (HELs) to national security needs. The potential for speed-of-light response with a wide variety of effects to support a variety of missions suggests a new level of flexibility and adaptability—attributes that are particularly valuable in the complex national security environment currently existing and unfolding. As in the case of most important new technologies, we are just beginning to understand and exploit the potential of high-energy lasers. It is nonetheless important to realize the extent of this potential. Directed-energy weapons can add a new dimension to a wide range of missions.

Appropriately developed and applied, high-energy laser systems can become key contributors to the 21st-century arsenal. Success for directed energy requires hard and expensive work to mature the technologies, develop operational systems, and apply the capabilities operationally. In the relatively near term, the new capabilities afforded by the use of high-power lasers could improve numerous aspects of warfare from initial detection and identification of targets to battle damage assessment after their attack. Directed-energy weapon systems, of the type discussed in this report, could be significant force multipliers providing “speed-of-light” engagement, unique damage mechanisms, greatly enhanced multi-target engagement, and deep magazines limited only by the fuel available. The use of these weapons offers the opportunity for the strategist to select from a range of lethal through non-lethal effects to the target system.

The laser beam delivers its energy to a relatively small spot on the target—typically a few inches in diameter. The incident intensity is sufficient to melt steel. Typical melt-through times for missile bodies are about 10 seconds. But if the heated area is under stress from aerodynamic or static pressure loads, catastrophic failure can occur more quickly. The beam can attack specific aim points on a missile that are known to be vulnerable; for example, pressurized fuel tanks or aerodynamic control surfaces. The laser weapon design, therefore, must include the ability to “see” and identify specific aim points, to put the beam on that aim point and hold it for a few seconds, and finally, to determine when the desired effect on the target has been achieved.

High-energy lasers have two characteristics that make them particularly valuable for effects-based application: they are extremely fast and extremely precise. The laser begins its attack within seconds of detecting its target and completes its destruction a few seconds later. This means the operator has time for multiple shots if needed to destroy the target or engage multiple targets.

In addition to the potential of high-energy lasers against moderately hard targets, several of the laser systems in development or under consideration could have the potential for lethal precision engagement against classes of soft targets, to include personnel and light vehicles. Hence, high-energy lasers hold the potential for precision attacks with precision effects to include lethal precision engagement that surpasses anything available in kinetic weapons. While there are a number of pacing technologies, the most basic remains the high-energy laser itself.

THE TASK FORCE CHARTER

High-energy laser systems provide the Department with unique opportunities to augment or improve operational capabilities and tactics in a variety of mission areas. In order for the Department to effectively incorporate HEL weapon systems into warfighting operations at the earliest possible opportunity, the Department initiated the Defense Science Board Task Force on High Energy Laser Weapon Systems Application.¹ The task force was asked to:

- Review current programs in HEL applications.
- Examine recent supporting technology advancements and their applications with respect to supporting military HEL weapon system developments.
- Develop potential military tactical and strategic HEL system applications and identify processes required to implement these potentials.
- Determine what remains to be done to “weaponize” these systems, including measures needed to allow them to operate and be supported in applicable combat theater environments.
- Assess HEL operational concepts, impacts, and limitations, considering legal, treaty, and policy issues concerning HEL employment.²

¹ Appendix A contains the complete Terms of Reference for the Defense Science Board Task Force on High Energy Laser Weapon Systems Applications.

² The task force spent considerable time on understanding the legal, treaty, and policy issues related to the employment of HEL systems but concluded that our understanding did not contribute enough to warrant inclusion in this report.

In addition, the task force was asked to make recommendations on:

- Needed additional research efforts that are not currently being addressed by the Department. These recommendations should encompass supporting technologies that enable military HEL applications.
- Potential strategic and tactical impact of HEL systems on future military operations compared to use of current systems.
- Capabilities of the U.S. defense industrial base to support development of HEL systems.
- Transition paths or roadmap for HEL weapons development and military applications.

SCOPE OF THE TASK FORCE WORK

Over the course of eight months, the task force reviewed the progress of HEL initiatives and activities and examined the potential of high-energy lasers for a wide variety of missions using a wide variety of platforms.³ The potential missions for HEL systems include ballistic missile defense, air defense, attack against ground and maritime targets, space control, and urban operations. The platforms include large aircraft, tactical aircraft including helicopters, ground vehicles, fixed ground sites, and spacecraft.

The task force heard briefings from the many communities engaged in the development of high-energy laser systems, subsystems and technologies.⁴ These communities included commercial industry, government and private laboratories, Service program offices, and the Defense Advanced Research Projects Agency (DARPA). The task force also talked to representatives of the Office of the Secretary of Defense (OSD) involved in HEL-related activities.

The task force examined ongoing initiatives and new applications for HEL systems. It examined the major issues confronting the development of HEL technologies and their transition into operational systems. The task force placed a great deal of emphasis on understanding the state of science and technology research and on identifying those areas of research offering the most promise in advancing HEL operational capabilities. Science and technology investments can have a significant impact on both the direction of current initiatives as well as new systems and approaches for using HEL weapon systems on the battlefield.

³ Appendix B contains a list of task force members.

⁴ A list of speakers and topics discussed can be found in Appendix C.

FINDINGS

Based on its review of ongoing and potential activities in high-energy laser research and development, the task force reached the following conclusions. These conclusions focus on five areas: the overall value of high-energy lasers, current initiatives, new applications, major issues in the development and application of HEL systems, and science and technology needs.

Overall, the task force believes that high-power lasers have the potential to change future military operations in dramatic ways. More specifically:

- High-energy laser technologies have matured to the point that a family of applications is feasible over the next two decades, to include systems on aircraft, space vehicles, ships, and ground vehicles.
- HEL systems are an area of technological advantage that can be exploited by the United States.
- HEL systems offer speed-of-light engagement of a variety of targets with the potential to produce a range of precisely controlled effects, as well as the potential for deep magazines, low cost per shot (or per kill), and reduced logistics footprint.
- There remain formidable science and technology tasks that must be addressed to realize the potential of high-energy lasers, to include work on a variety of laser sources, beam control, power generation and storage, thermal management, atmospheric understanding and compensation, and weapons effects.
- There are continuing engineering challenges to improve reliability and reduce the cost and size of HEL systems, especially for tactical applications.
- The United States has underfunded basic (6.1) and exploratory development (6.2) research on high-energy laser technologies.

The following tables contain the remaining findings, followed by the task force recommendations. At the conclusion of this chapter is a table that summarizes the program status and funding requirements both for current high-energy laser initiatives and for new applications that are early in development or on the horizon.

Findings: Current Initiatives	
Airborne Laser (ABL)	<p>The Program Definition and Risk Reduction (PDRR) phase provides a well-defined path to an operational system exploiting the currently most mature chemical oxygen-iodine laser (COIL) technology.</p> <p>The PDRR aircraft will be required for several years after the ABL reaches an initial operational capability to continue capability growth of the ABL system in addition to operational concept development.</p> <p>An initial capability could be fielded by 2010.</p> <p>ABL has the potential to contribute to multiple missions in addition to the theater missile defense boost-phase intercept, to include enhanced range theater missile defense link-up through the EAGLE relay mirror constellation (described below), aircraft self-defense, launch site location, impact point location, imaging surveillance, and cruise missile defense.</p> <p>A robust continuing technology effort is required to realize potential capabilities.</p>
Space Based Laser (SBL)	<p>The project office has identified 13 specific issues that require experiments in space to develop or validate design information. Several of these are identified as high-risk elements by the project office.</p> <p>The current Integrated Flight Experiment (IFX) plan is to address 12 of the 13 issues in a single, first IFX in space. This approach produces an IFX with multiple high-risk elements. One significant issue—deployable optics—is to be addressed in a separate part of the program consisting principally of sub-scale and full-scale ground demonstrations. Currently deployable optics research is not funded.</p> <p>Based on existing, demonstrated component maturity and postulated extension of technology development, a proposed initial operational design would use an 8- to 10-meter monolithic or segmented mirror. The system would weigh some 80,000 pounds.</p> <p>There is no planned U.S. launch vehicle that could accommodate either an 8-meter fairing or an 80,000-pound payload, though there are design studies for such a system.</p> <p>Deployable optics could bring the fairing size within planned capabilities of the U.S. heavy launch system and allow deployment in two segments with on-orbit assembly or possibly in a single segment if weight could be sufficiently reduced.</p> <p>Both options require significant science and technology (S&T) efforts, which are not currently funded.</p>

	<p>The performance growth from IFX to an operational system defined in the SBL Affordability and Architecture Study requires significant scaling in laser system performance. Specifically, there is a 5- to 8-fold increase in laser power, a 2- to 3-fold increase in aperture diameter, a 2-fold improvement in wavefront error correction, and a 2- to 3-fold improvement in jitter correction. A funded SBL technology program is needed to provide these performance improvements. Delaying this technology program until after the IFX program is completed will significantly delay any operational capability.</p> <p>A robust S&T program is needed to provide alternative space-qualified HEL sources for an operational SBL, involving short-wavelength lasers such as hydrogen fluoride-overtone, space-based COIL or other iodine lasers, or solid-state lasers (SSL).</p> <p>An extensive continuing development program is needed to mature system capability for insertion beyond an initial operational capability. Potential development paths include closed-cycle chemical lasers, electrically driven lasers, and beam quality compensation.</p> <p>Though the current architecture studies conclude that space-based systems out-perform ground-based and space-based relay mirrors, these results are highly dependent on the underlying assumptions. A balanced long-term technology investment is needed for space-based lasers, ground-based lasers, and space-based relay mirrors.</p>
<p>High Energy Laser System – Tactical Army (HELSTAR)</p>	<p>The Tactical High Energy Laser (THEL) Advanced Concept Technology Demonstration (ACTD) has demonstrated the capability to intercept and destroy Katyusha class rockets as part of a cooperative U.S. Department of Defense-Israeli Ministry of Defense (USDOD-IMOD) development program. The THEL ACTD has demonstrated the operational feasibility of a complete tactical fire control system coupled to deuterium fluoride (DF) laser technology in a transportable configuration. The rockets are a key part of the threat in the Army-envisioned Extended Area Air Defense System (EAADS) Operational Requirements Document (Draft).</p> <p>The Mobile THEL follow-on program will continue the USDOD-IMOD efforts aimed at producing a more compact, mobile version of the DF laser system. The initial study phase will consider comparable EAADS requirements in evaluating alternative designs.</p> <p>A U.S.-only version of THEL—called HELSTAR—is a response to evolving future requirements such as EAADS and the Future Combat System (FCS) and is under consideration. Alternative laser technologies—the solid-state heat capacity laser and the electro-chemical (EC) COIL—are part of the long-term set of alternatives.</p>

Findings: New Applications	
Airborne Tactical Laser (ATL)	<p>The ATL ACTD provides a potential path to roll-on, roll-off HEL capability on tactical transport and large, helicopter-sized platforms compatible with Air Force, Navy/Marine Corps, and Army platforms. The initial ATL concept requires a sealed exhaust system, which is to be demonstrated as part of the ACTD—a need that is compatible with the EC-COIL Fuel Regeneration System (FRS) also needed for the HELSTAR set of programs. Potential growth paths to solid-state lasers are included in longer range planning.</p> <p>Successful demonstration of the ATL ACTD also depends on significant advances in precision beam control in a cluttered environment for the lower-altitude, turbulent atmosphere—including the added turbulence generated by the downwash of rotor systems or the boundary layer around aircraft.</p>
Ground-Based Laser for Space Control	<p>A continuous wave (CW) system with a power output of several megawatts, having the potential to be highly effective against low-orbit satellites, and with some effectiveness against synchronous orbit satellites, is within the state-of-the-art. Much of the technology and required levels of performance have been demonstrated or are under current experiment, but there is still some significant S&T work that must be accomplished.</p>
Evolutionary Aerospace Global Laser Engagement System (EAGLE)	<p>Space-based mirrors (SBMs) that relay high-energy laser beams may offer a significant future enhancement to high- and low-energy applications.</p> <p>Ground-, sea-, air-, and space-based lasers can feed the SBMs to carry out applications such as ballistic missile defense, space control, and force application against ground, sea, and air targets. In addition, SBMs potentially offer significant stand-alone command, control, communications, and computers and intelligence, surveillance, and reconnaissance (C4ISR) capabilities. However, SBMs alone may not provide a viable missile defense, so ensuring that the laser sources work should still be central to the DoD mission.</p> <p>Relay mirrors may offer a more cost-effective way to carry out multiple missions than single, non-space-based systems operating alone.</p> <p>S&T and integrated demonstrations are needed to demonstrate acquisition, pointing and tracking, dual-line-of-sight momentum control, and high-efficiency throughput at the relay mirror.</p> <p>For longer-range applications, such as ballistic missile defense, deployable optics may be required for enhanced capability systems.</p>

<p>Tactical High Energy Laser Fighter</p>	<p>With technology investment, an HEL fighter could be ready for Engineering and Manufacturing Development (EMD) in approximately 10-15 years. Key technical development needs include significant improvements in the power-to-weight/volume ratio of the laser system, beam control in a high vibration/acoustic environment, and thermal management.</p> <ul style="list-style-type: none"> • Nearer-term applications at low and moderate power levels (1 KW to 30 KW) are both possible and highly desirable. They will allow fuller understanding of the benefits of lasers in the tactical environment, assuming the challenges of scaling and packaging are solved. • These applications may include advanced sensing, aircraft protection against surface- and air-launched missiles, and air-to-air combat.
<p>Future Combat Systems (FCS)</p>	<p>Given developments that provide the needed deployability and battlespace mobility, HEL systems can contribute significantly to FCS concepts in the areas of counter-surveillance, active protection, air defense, and clearance of exposed mines.</p> <p>A relevant system—based on a solid state heat capacity laser (SSHCL), DF laser, or COIL—could be ready for experimentation by about 2006, if funded.</p> <p>The Army’s solid-state laser technology program, albeit immature, shows great promise as a technology that could significantly enhance the Objective Transformation Force while meeting the needs for mobility and supportability.</p> <p>The Army’s programmed investment in solid-state HEL weapon systems, in particular the 100 KW demonstrator, is inadequate to move this technology to sufficient maturity to support an acquisition decision this decade.</p> <p>The operationally limiting factor for the SSHCL is duty cycle. The operationally attractive factor is the use of fuels common with the rest of the force.</p> <p>The constraining challenges for the DF laser are size, weight, and the need for fuel resupply and a pressure recovery system. The advantage of DF technology is its demonstrated maturity.</p> <p>The effects of the battlefield environment on the effectiveness of a force using high-energy lasers are yet to be fully understood. Significant efforts are needed in order to make proper trade-offs between the choice of laser type and concepts of operations as a function of threat tactics.</p> <p>Sealed exhaust COIL technology would become competitive given the successful demonstration of an HEL Fuel Recovery System.</p> <p>Fire control will be a major challenge for HEL contribution to the FCS. The fire control technology developed for the THEL ACTD is a good start towards meeting FCS requirements, but further progress will be needed in size and robustness.</p>

Counter-munitions	The ZEUS™ system, integrated onto a High Mobility Multi-Purpose Wheeled Vehicle (HMMWV), provides a capability to neutralize surface mines and unexploded ordnance. A prototype 500-watt laser has been tested. A program is underway to upgrade the system to 1 KW. The system could be procured as a near-term capability or be incorporated as part of the HELSTAR.
Maritime Self-Defense	<p>A properly designed high-energy laser weapon system could be a highly flexible naval capability for needs ranging from testing hostile intent to lethal engagement.</p> <p>Given the difficulty in handling laser chemicals shipboard and the electrical power available on modern Navy ships, the family of electrical lasers, including free-electron lasers and solid-state lasers, are logical candidates for maritime self-defense.</p>
Large Aircraft Self-Defense	The use of directed-energy laser defensive systems on long-range aircraft, such as bombers, has promising potential, but needs considerable study and research to determine its technical and operational feasibility.

Findings: Major Issues	
Atmospheric and Propagation Effects on HEL Performance	<p>Renewed interest in tactical HEL applications (such as mobile THEL, the ATL, and maritime self-defense) requires expanded efforts to measure and understand low-altitude, “thick-air” atmospheric effects.</p> <p>Primary concerns include the effects of atmospheric turbulence and aerosol scattering on the HEL beam. Non-linear propagation effects such as thermal blooming can also have important effects for many applications.</p> <p>Technical remedies are available to deal with atmospheric turbulence, but much more understanding is needed, as is the ability to predict and measure atmospheric turbulence.</p> <p>Non-linear propagation effects require detailed analyses and experiments. They also require beam control concepts to ameliorate the negative effects. No such analyses or experiments exist for multi-pulse systems.</p>
Understanding Effects and Vulnerability	Only limited relevant data exist on directed-energy weapons effects. While a large number of experiments have been conducted, there is an urgent need for a systematically obtained, archived, and understood set of directed-energy effects on targets of military significance. The equivalent of the Joint Munitions Effectiveness Manual for kinetic-energy weapons is needed.

<p>Modeling and Simulation</p>	<p>Much of the characterization of the interaction of an HEL beam with targets of military significance has been validated over only a limited range. These predictive methods are empirically based, with general theoretical treatments anchored by limited experimental testing. Detailed treatment of the underlying physics is necessary.</p> <p>There is insufficient validation of lethality mechanisms under conditions in which measurements of reasonable fidelity can be made.</p> <p>There is insufficient definitive information to properly characterize the atmospheres within a battlespace, at least to the extent needed to provide a predictive capability.</p> <p>There is insufficient effort being directed at modeling the entire optical train for any system, starting from an HEL resonator and proceeding through the beam control system and exit aperture to the target.</p>
<p>Beam Control</p>	<p>A balanced investment strategy is needed that addresses the full spectrum of required beam control development activities for first- through third-generation HEL systems and for potential applications and system implementation concepts.</p> <ul style="list-style-type: none"> • Beam control technology and functions cut across applications, lasers, platforms, and missions. • Current coordination of ongoing programs avoids duplication but does not provide a centralized management (planning) function responsible for beam control technology developments for all mission areas and applications. <p>Beam control component technology development has been seriously neglected for the last 8-10 years.</p> <ul style="list-style-type: none"> • Technology for second- and third-generation systems is seriously lacking. • First-generation integrated demonstration programs will not produce advanced beam control technology for follow-on generation systems. <p>Integration (subsystem and system level) is a major issue in the development of beam control technology.</p> <ul style="list-style-type: none"> • The few ongoing advanced technology integration programs (maturing technology for second-generation systems) are significantly underfunded. • No advanced technology integration programs are currently underway or planned for third-generation systems.

Findings: Science and Technology

The core HEL S&T funding is insufficient to realize the clearly defined potential contribution of HEL to future military capabilities. Considerably more funding (\$100-150 million per year) is needed.

A new DoD HEL S&T investment strategy is needed. The strategy should be based on determining top-level systems needs, assessing critical technology barriers to meeting those needs, and funding the research needed to overcome the barriers. In the face of funding pressures, the practice of providing inadequate funding to a wide variety of programs should be replaced with focused, sequential developments funded at the level of effort needed to make real progress.

Specific science and technology needs include:

Lethality	<p>Effects of HEL weapons against targets of military significance.</p> <p>Investments to characterize the potential advantages of pulsed versus continuous irradiation.</p> <p>Predictive capability to support HEL system fire control and battle space management.</p>
Atmospheric Propagation & Compensation	<p>Understanding and correcting for atmospheric effects. This is true for all ground and atmospheric laser weapon systems, but is especially relevant in tactical scenarios.</p>
Modeling and Simulation	<p>Improvements in the fidelity of modeling and simulation for laser devices, beam control, propagation, lethality, and overall system performance. In addition, an integrated modeling capability for system performance prediction is needed.</p>
Deployable Optics	<p>Large, lightweight, deployable optics for high-power space-based applications.</p>
Solid-State Laser	<p>Phased combining of laser modules.</p> <p>Designing and manufacturing reliable diode pump lasers.</p> <p>Thermally controlling solid-state lasers.</p> <p>Scaling of the output power to weapon class systems at weights and cost per watt comparable to chemical lasers.</p>
COIL or Other Iodine-Based Short-Wavelength Lasers	<p>Technology to make COIL appropriate for space and tactical applications: 1) operation in a zero gravity environment and 2) closed-cycle operation.</p> <p>Minimize logistical supply needs.</p> <p>Management of the exhaust (such as sealed exhaust).</p>
Hydrogen Fluoride (HF)/DF Lasers	<p>Demonstrate a highly focused beam (either uncorrected or with adaptive optics).</p>

Beam Control	Investments to develop low-cost components and optical metrology techniques. Integration of propagation and lethality predictions into the HEL system. Novel techniques such as phased-array beam control and electronic beam steering.
Optical Components	Significantly increase technology development to improve system performance and preserve fragile manufacturing base.
Free-Electron Lasers	Technology investments focused on scaling to average powers in excess of a megawatt. Specific investment areas include high average current injectors, electron beam transport, and high-power optical resonators and undulators.

RECOMMENDATIONS

Based on its findings, the task force offers the following recommendations:

1. Airborne Laser (ABL)

While continuing to focus the PDRR phase on earliest practical deployment, the Air Force should fund a robust technology effort to evolve the ABL to a more capable and supportable future system.

The Air Force should program the PDRR aircraft for continuing evolution of ABL capabilities by the development community, while further developing the concepts of operations.

2. Space-Based Laser (SBL)

- **Integrated Flight Experiment (IFX).**

The Ballistic Missile Defense Organization (BMDO) should:

Give high priority to reducing the number of high-risk elements in the currently planned IFX program.

Reevaluate the relative cost and schedule risk of the current plan to bundle multiple high-risk elements into a first in-flight experiment versus a series of lower-risk experiments preceding and following the first attempted lethal demonstration.

Include deployable optics technology development as part of a comprehensive science and technology (S&T) program along with other necessary SBL S&T efforts.

- **Initial operational system.**

BMDO should:

Fund a robust S&T effort to address the significant scaling required in going from IFX to operational capabilities. Specific efforts should include short-wavelength space-, aircraft-, and ground-based laser sources.

Intensify the development efforts to provide options for the growth path to initial operational capability—deployable optics, short-wavelength lasers, beam control, and space support technologies.

Develop an on-orbit servicing and assembly capability through technology development and on-orbit demonstrations.

Conduct a continuing cost and risk trade-off between (1) size and weight reduction to fit planned launch capabilities and (2) increased lift capacity, to make a timely decision on launch capability needs.

- **Further operational system upgrades**

The Under Secretary of Defense for Acquisition, Technology and Logistics (USD(AT&L)) should pursue advanced technologies to include solid-state and closed-cycle chemical lasers. This should be part of the robustly funded S&T effort.

As technology develops, BMDO should evaluate a balanced system of space-based lasers, airborne lasers, ground-based lasers, and space-based mirrors to meet the ballistic missile defense mission need.

3. High Energy Laser – Tactical Army

While continuing to move towards deployment of a mobile system using a deuterium fluoride chemical laser, the Army should broaden efforts toward development of laser technologies for a more robust, supportable system—closed-cycle chemical, solid-state, and fiber lasers. Program options for choosing a new laser should be kept open as long as possible.

4. New Applications

The USD(AT&L) should establish a continuing review program involving the Services, the Joint Chiefs of Staff (JCS), and OSD to evaluate operational potential of high-power laser applications as technologies mature. Include:

- Advanced Tactical Laser
- Ground-Based Laser
- Evolutionary Aerospace Global Engagement System
- Tactical High Energy Laser – Fighter
- Future Combat System applications
- Countermunitions
- Maritime Self-Defense
- Large-Aircraft Self-Defense

5. Technology Program

The USD(AT&L) should create a coherent, department-wide, prioritized technology program to support the growing family of potential HEL applications. The needed increase in funding is judged to be \$100 to \$150 million per year. The program should include the following:

- *Lethality.* Pursue a vigorous program to quantify the potential advantages of short-pulse lasers, and develop a predictive capability at a system level to support HEL system fire control and battle space management.
- *Atmospheric Propagation and Compensation.* Greatly expand efforts to understand and correct for atmospheric effects, especially in tactical scenarios. Compensation for scintillation effects should be included.
- *Modeling and Simulation.* Significantly improve the fidelity of modeling and simulation for lasers, beam control, propagation, lethality, and overall system performance. More accurate wave optics models should be developed. More extensive comparisons between models and data are needed.
- *Deployable Optics.* Start a new technology development program in large, lightweight, deployable optics for high-power space-based applications.

- *Solid-State Lasers.* Increase technology efforts focusing on four keys to high energy: 1) combining laser beams, 2) designing and manufacturing reliable diode pump lasers, 3) thermal control of laser media, and 4) scaling the output power and weight/cost per watt to weapon class systems.
- *COIL or other Iodine-based Lasers.*
 1. Develop technology to make laser sources appropriate for space and tactical applications: 1) capable of operation in a zero-gravity environment, 2) capable of closed-cycle operation, and 3) lighter weight.
 2. Evaluate novel approaches to pumping chemical lasers including electrical and optical methods.
- *HF/DF Lasers.* Demonstrate a nearly diffraction-limited beam at high power (either uncorrected or with adaptive optics).
- *Beam Control.*
 1. Develop low-cost components, optical metrology, and alignment techniques, and integrate propagation and lethality predictions into the HEL system description.
 2. Initiate a long-range effort in novel techniques such as phased-array beam control, electronic beam steering, and non-linear phase conjugation.
- *Optical Components.* Significantly increase technology development to improve system performance and preserve fragile manufacturing base.
- *Free-Electron Lasers (FELs).* Substantially increase technology efforts focusing on key elements of: 1) scaling FELs to higher powers and 2) demonstrating the ability to field for military applications. Specific investment areas include high average current injectors, electron beam transport, high-power optical resonators, beam expanders, and undulators.

The task force supports continued development of HEL systems, but emphasizes the need for a sustained, department-wide science and technology investment supported by significantly more resources than are currently allocated.

HEL Project Status Summary

Project	Current Status	Date to Reach Milestone B SDD	Risk	Funding Required to Reach Milestone B
ABL	PDRR	04	Med	\$690M
ABL Tech Insertion Options for EMD	TRL 4 S&T (6.3)	04	Med	\$45-50M
SBL IFX	IFX	TBD	Med/High	
SBL Operational System Technology Development**	S&T (6.3)	10	Med	
THEL ACTD	ACTD	02	Low	\$10
	TRL 7			
MTHEL (US/IS)	Pre MS A	07	Med	\$175M US \$175M IS
	TRL 4			
HELSTAR	Concept			TBD
DF	Leverages MTHEL Sys Eng Study			TBD
EC-COIL	Leverages ATL ACTD			TBD
SS HCL	Same as FCS SSL HCL			TBD
ATL	ACTD	05	Med	\$80-200M
SE-COIL	TRL 3			
GBL	S&T (6.3)	06	Med	\$40M
	TRL 5			
Tactical HEL Fighter	S&T (6.2/6.3)	09	High	\$400-500M
	TRL 2			
EAGLE	S&T (6.2/6.3)	09	High	\$600-800M
	TRL 4			
FCS	Concept			
SS HCL Demonstrator	S&T (6.2)	06	Med/High	\$200-300M
	TRL 3			
EC-COIL w/FRS	S&T (6.2)	Leverages ATL ACTD and JTO Funding	Med/High	TBD
	TRL 4/2			
Countermunitions Zeus™	S&T (6.3)	02	Low	\$20M
	TRL 3			
Maritime Self-Defense	S&T (6.2/6.3)	09	Med	\$300-400M
	TRL 3/4			
Large Aircraft (Bomber) Self-Defense***	S&T (6.2/6.3)	TBD based on requirements	Med	TBD based on requirements****

** SBL technology includes a broad range of 6.2 and 6.3 efforts, including laser devices, beam control, and large optics. Some of the beam control and large optics efforts are also included under the "EAGLE" concept.

*** The Large Aircraft (Bomber) Self-Defense concept was demonstrated in an integrated flight demonstration by the Airborne Laser Laboratory (ALL). Detailed designs were completed for predecessor laser technology in the early 80s. These analyses and designs need to be updated using current technology if a specific requirement exists.

**** The technology required for bomber defense is similar, but less stressing, than that for the xTactical HEL Fighter and ABL. The work under those projects is directly applicable, and a larger trade space exists for the bomber than the fighter. Some unique aspects may exist.

CHAPTER I. CURRENT INITIATIVES

The Department of Defense currently has three major initiatives underway involving high-energy lasers (HELs): the Airborne Laser (ABL), the Space-Based Laser (SBL), and the Tactical High Energy Laser (THEL). The ABL is the furthest along in its development, having entered the Program Development and Risk Reduction phase in 1996. An initial operational capability for this boost-phase ballistic missile defense (BMD) system could be achieved in about 2010, following an aggressive testing schedule in the next few years. The Space-Based Laser project—a system also designed to destroy targets in the boost phase—is still in the very early development stage, with no decision at this time to pursue an operational system. Should a decision be made, initial operational capability is at least two decades away. The High-Energy Laser System-Tactical Army (HELSTAR), a U.S.-only version of THEL, is under consideration to be funded as a new program. This system would provide HEL capability for the Army’s Enhanced Area Air Defense system and other applications.

Each of these systems has the potential to contribute to multiple missions and provide a significant technological advantage to the warfighter. Technologies for high-energy lasers have matured to the point that a family of applications is feasible in the next few decades. A common thread in these initiatives, however, is the need for more robust science and technology investment to realize cost-effective operational capabilities.

Key S&T issues, that have an impact on all initiatives in this and following chapters, include pointing and tracking accuracy, beam control, and beam propagation in a battlefield environment or during poor weather conditions. In the case of laser weapons, lethality effects against a variety of targets must also be clearly understood. More specifically, these concerns are:

- *Pointing and tracking accuracy* is the ability to point the laser beam to the desired aimpoint and to maintain that aimpoint on the target.
- *Beam control* refers to forming and shaping the beam. Depending on the nature of the specific laser, beam control can include initial processing of the beam to shape it and eliminate unwanted off-axis energy, or can include wavefront shaping and/or phase control.
- *Beam propagation* describes the effects on the beam after it leaves the HEL output aperture and travels through the battlefield environment to the target. Optical stability of the platform and beam interactions with the atmosphere, both molecules and aerosol particles, primarily determine the laser beam quality at the target. Beam quality is a measure of how effective the HEL is in putting its light into a desired spot size on the target.

- *Lethality* defines the total energy and/or fluence level required to defeat specific targets. The laser energy must couple efficiently to the target, and it must exceed a failure threshold that is both rate-dependent and target-specific. Laser output power and beam quality are two key factors for determining whether an HEL has sufficient fluence to negate a specific target, as Figure 1 illustrates.

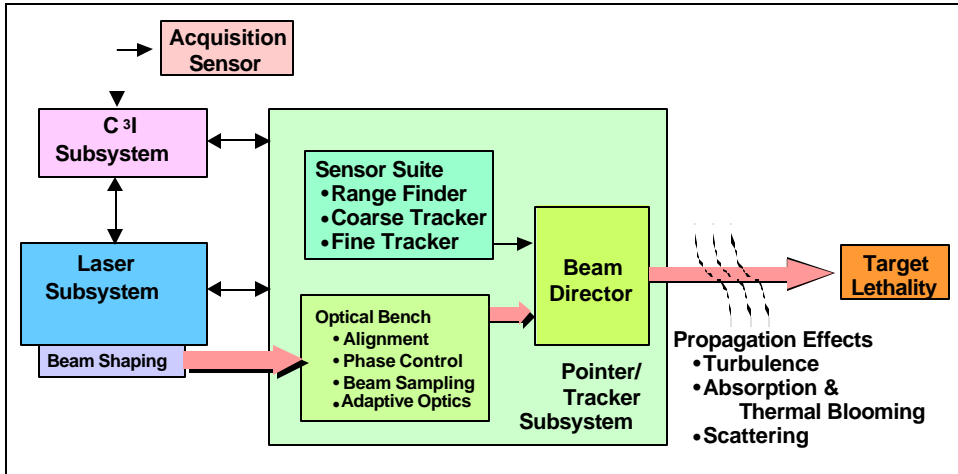

Figure 1. Common High Energy Laser Technology

This chapter describes the ABL, SBL, and HELSTAR initiatives, highlighting the science and technology (S&T) requirements needed to advance each system to an operational capability.

AIRBORNE LASER

The Airborne Laser is a multi-megawatt laser based on a 747 aircraft platform. The system can engage theater ballistic missiles (TBMs) in flight at a several-hundred-kilometer standoff range, as depicted in Figure 2. In theater, the ABL will not require deep penetration into enemy airspace. Nevertheless, the laser device will provide the aircraft with a self-defense and counter-air capability. Furthermore, though its primary mission will be missile defense, the system also has applications in other missions, to include intelligence, surveillance and reconnaissance (ISR); counter-air; and counter-space.



Figure 2. Airborne Laser Concept

PROGRAM DESCRIPTION

The ABL program is integrating a multi-megawatt chemical oxygen iodine laser (COIL) into a modified Boeing-747 to destroy boosting TBMs. The aircraft laser system consists of four main assemblies:

- The laser assembly to provide laser power.
- The beam control assembly that acquires the target, aligns the laser, and compensates for atmospheric distortion.
- The battle management and communications, command, control and intelligence subsystem to provide engagement and fire control.
- The turret assembly that locates and tracks targets and propagates the laser beam.

The turret assembly contains a 1.5-meter-diameter telescope and is mounted on the nose of the aircraft. Six onboard infrared sensors will provide 360 degrees of coverage to autonomously detect missile boost motor plumes. The aircraft, cruising at approximately 40,000 feet, will use the high-energy, 1.3-micron-wavelength laser to heat missile structures to their failing point.

ABL is to have a salvo engagement capability to destroy 20 to 40 enemy missiles. With in-flight refueling, a few ABL aircraft could, for an extended period, provide protection for allied forces and theater civilian centers against the missile threat during a regional conflict. The ABL is to be able to operate effectively as part of a tiered theater missile defense, operating in concert with various ground-based and sea-based systems, as the concept of operations in Figure 3 illustrates. The system can also be deployed singly to a threat area in the absence of other systems.

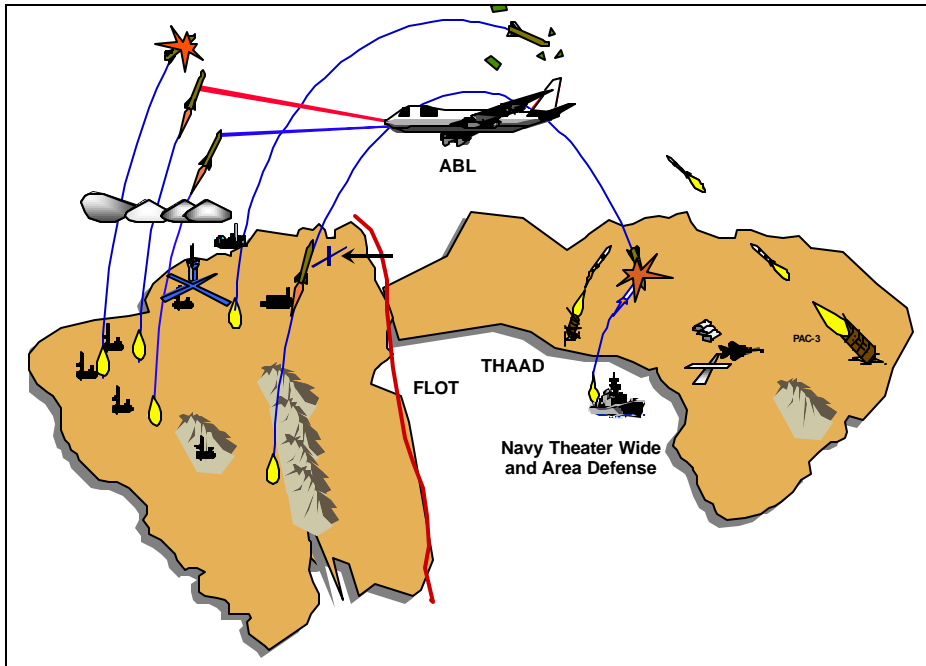

Figure 3. ABL Concept of Operations

Requirements

The ABL program requirements are found in the Theater Missile Defense (TMD) Mission Need Statement (MNS), approved in November 1991 with a second revision approved in July 1999, and the ABL Operational Requirements Document (ORD), signed in October 1996 with a second revision in December 1999. In addition to its ballistic missile defense mission, adjunct missions could include:

- “detect and warn of [radio frequency] RF, [electro optical] EO, [infrared] IR, acoustic threats to aircraft”
- “improve countermeasures to RF, EO, IR, acoustic threats to aircraft”
- “neutralize enemy air defenses”
- “improve range and reduce risks for target engagement”
- “provide nuclear, chemical, and biological (NBC) contamination avoidance”
- “improve NBC target detection”
- “provide offensive counterspace capability”

Capability Assessment

The contributions of ABL to the Expeditionary Air Force could apply to multiple missions. Its primary role is that of mobile, rapid-response theater missile defense, providing an added layer to the missile defense capabilities of midcourse and terminal systems. In the absence of ground and sea defenses, either early in a conflict or in restricted locations where such assets could not be deployed, the ABL could offer the only means of missile defense. ABL is expected to lower the overall “leakage rate” of threats by an additional 25 percent against a moderate missile attack. If ABL is the only system present, each aircraft is able to negate up to 20 moderately sophisticated attacking missiles.

In addition to its TMD role, the ABL could also provide contributions to missions of ISR, counter-air, and counter-space. Deployed in conjunction with other air assets, it could provide extended reach to augment other counter-air assets in negating enemy aircraft. It could also target an adversary’s satellites to blind his ability to see the battlefield or conduct extended communications.

An additional application for the ABL might be to improve ability to assist midcourse BMD systems in discriminating warheads from decoys. The laser could destroy or disturb lightweight decoys. The resulting dynamic could then be detected by BMD radars and/or by the onboard sensors in the interceptor.

Schedule and Funding

The ABL program is scheduled to reach initial operational capability (IOC) late in the 2000-decade; a projected date for full operational capability (FOC) has not yet been determined. The first lethal intercept demonstration is scheduled to occur in 2003, as Figure 4 indicates.

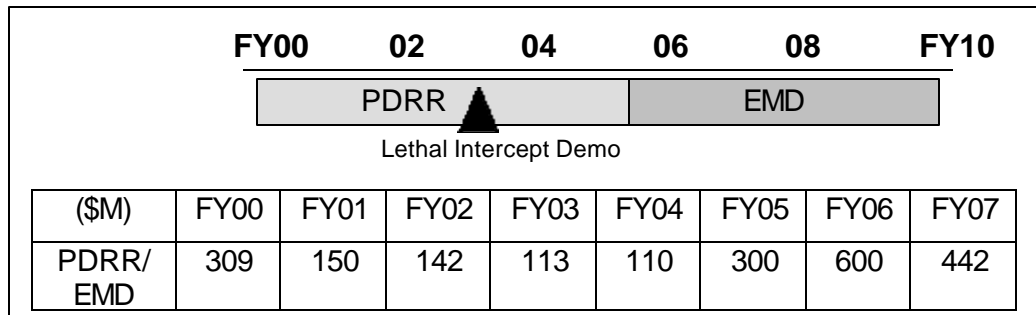

Figure 4. ABL Program Schedule and Funding

PATH TO OPERATIONAL SYSTEM

Following a three-year demonstration and concept definition effort, the ABL program entered into the Program Definition and Risk Reduction (PDRR) phase in late 1996. The PDRR phase is well underway, with modification of the designated Boeing 747 to be completed in mid-2001. Upon completion, the airplane will undergo airworthiness testing until early 2002. The battle management and communications, command, control and intelligence subsystem and the laser beam control and fire control subsystems will then be integrated into the airplane. Flight-testing will follow, to assure readiness for the laser subsystem integration.

The complete system will then undergo extensive flight-testing that will culminate in a test against an actual TBM during boost phase. The demonstration is planned in the late-2003 time period. This demonstration, combined with other supporting analysis and data, is intended to constitute proof of feasibility to proceed with the Engineering and Manufacturing Development (EMD) phase on route to developing and acquiring an ABL operational capability.

The program concept is to evolve from the PDRR configuration to an operational configuration by straightforward scaling and minor refinement of the PDRR hardware. Thus, the changes to be made would be incorporating additional modules of the laser subsystem to achieve the desired output power and more technologically advanced components to improve reliability and producibility or to lower cost. Assuming a successful PDRR phase and demonstration, EMD could begin in early 2004 and result in an operational capability in the mid-to-late 2000-decade.

SCIENCE AND TECHNOLOGY ISSUES

In addition to the ABL acquisition program, an Air Force science and technology program, shown in Figure 5, is currently underway to enhance system performance above what will be demonstrated on the PDRR aircraft.

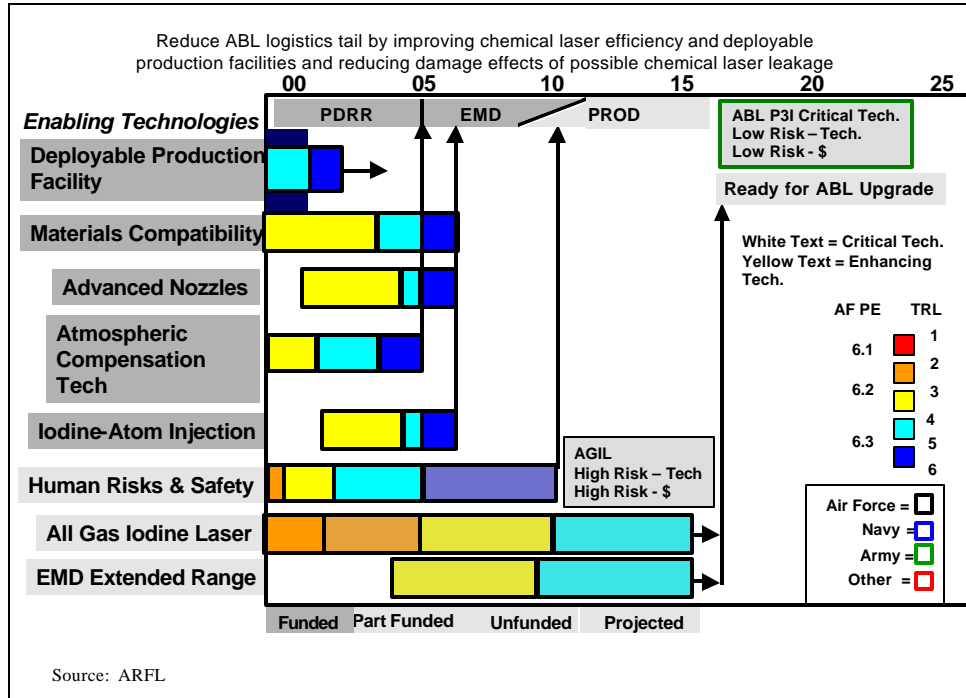

Figure 5. ABL Long-Term Advanced Technology Development Plan

Advanced Technology Demonstration

To develop and demonstrate technology to improve performance for the ABL, the Air Force is conducting an advanced technology demonstration (ATD), described in Figure 6. The ATD is intended to demonstrate advanced technology at a level of maturity that will support transition to an operational ABL system. Specifically, technology transition is targeted for the ABL EMD design update, planned for early FY 2004. Specific demonstrations involve ground testing of atmospheric compensation and tracking scaled to replicate the propagation conditions expected in theater missile engagement scenarios. ABL technology objectives are to increase the atmospheric compensation and beam jitter Strehl ratios (ratio of beam intensity achieved compared to the ideal) by a factor of two and to increase the power of the laser device (power per unit weight).

Tracking, adaptive optics, and laser device technologies developed under this ATD should pay off in enhanced operational capability of the ABL weapon system. If objectives can be met and the technology transitioned to the ABL system, the operational range could be increased by approximately 25 percent, and the available lasing time could be increased by 25 percent without any changes in overall ABL laser system weight.

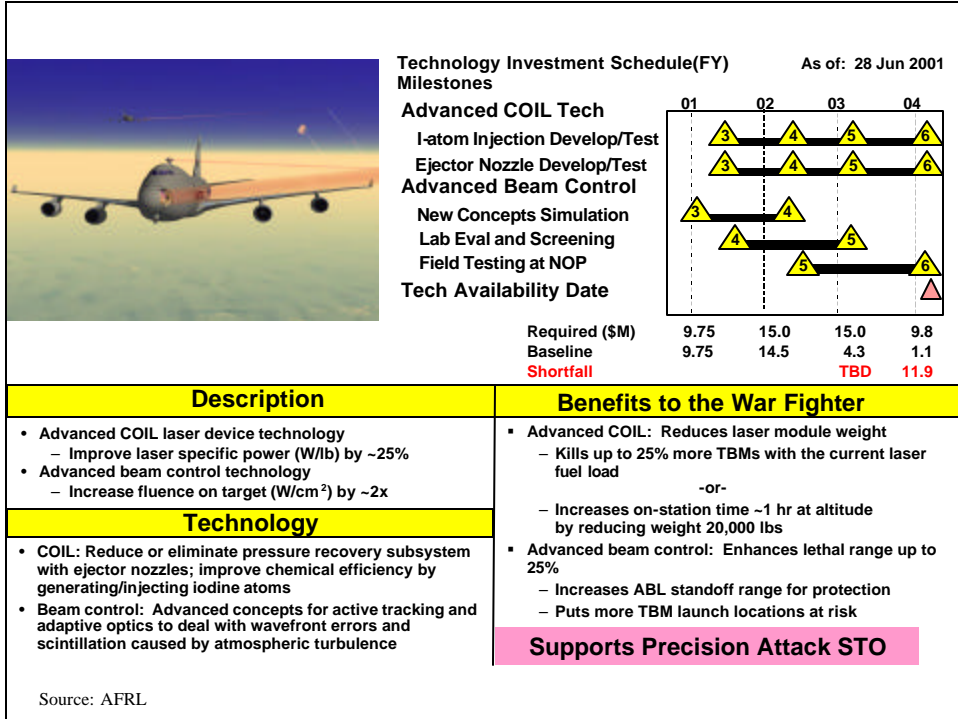

Figure 6. Airborne Laser Weapon System ATD

Long-Term S&T Needs

In the long term, for the ABL to serve as an affordable primary boost-phase BMD system, the cost and effectiveness of the system will have to be improved to the point where enough systems can be deployed to provide continuous coverage in a theater. To achieve this capability will require advances in a number of technologies supported by a focused S&T program. Included in such a program should be efforts in the following areas:

- Atmospheric Compensation.** It may be possible to significantly improve the ability to compensate for the thick lens effects of the long path through the atmosphere at ABL operational ranges. It is conceivable that the amount of fluence on target could increase by another factor of two if this could be accomplished. The resulting high beam intensity at the target could then be traded for either a lower laser output power, higher probability of target kill, or smaller beam director aperture size.
- Advanced Lasers.** The laser employed in the current demonstration system appears workable and is the only candidate available for this application at this time. However, it has a number of shortcomings that might be overcome with advanced laser

designs. In particular, if electrically powered solid-state lasers of a megawatt-output power class could be developed, several problems with the current laser could be overcome. Such a laser system would employ electric power derived from the aircraft propulsion system, which typically has several tens of megawatts of power capacity. Since the propulsion system has many hours of fuel capacity, the laser magazine capacity could be greatly increased. In addition, the need for a logistic supply of the specialized fuels needed by the current chemical laser would be obviated. Finally, the safety issues associated with such fuels could be alleviated.

- *Advanced Beam Control.* With a solid-state laser, it might be possible to develop optical phased arrays similar to those now being deployed for airborne radar applications. With such arrays, it might be possible to employ near conformal fixed laser arrays on the airframe, thus greatly simplifying the mechanical and window problems of the current system. While such a capability would require very significant technology advances, it would offer the potential for a number of other airborne laser weapon applications, such as bomber and fighter defense against missile attack and reduction of the size of boost-phase missile defense systems.

Impact of ABL Technology Development

Technology development for the ABL will have an impact not only on its primary mission—to destroy a boosting missile in flight—but also on other missions and on the effectiveness of future airborne systems in general. The ABL demonstration will be a dramatic example of the value of high-energy lasers on the battlefield, but the utility of the demonstration aircraft will not end there. Indeed, the most important use of the demonstration aircraft will be to verify models of lethality and atmospheric compensation. It is to be expected that testing following the actual missile shoot-down will include investigation of the effectiveness of high-energy lasers for attacking targets other than missiles, such as aircraft, cruise missiles, and ground vehicles. The development of new missions will be critically important for the EMD phase of system development and, indeed, for defining the future of high-energy lasers in warfare.

Although the airborne laser system is designed to carry out a well-defined existing mission, many new techniques and technologies will enhance the operation of the weapon in the future. In particular, current atmospheric compensation technology does not address the issue of compensating for scintillation in the atmosphere. Scintillation is simply considered as a power loss that is balanced by an increase in the power of the laser. Thus, scintillation is not an issue for initial deployment of the

system, because loss resulting from scintillation is included in the current system design. In the future, however, as demands for longer range and new missions present themselves, it will become a prime candidate for the development of new science and technology. Basic research into the properties of a turbulent atmosphere will be necessary.

As new missions are identified, dwell time and magazine depth will become more important. Both of these quantities depend on properties of the atmosphere, but they also depend directly on laser efficiency. Methods for increasing the efficiency of the COIL are being explored, and close watch on these techniques should be maintained. New laser designs should be injected into the ABL program when it is clear that performance will be improved. For the long term, however, it may be necessary to develop new lasers to guarantee the effectiveness of future airborne systems.

TASK FORCE FINDINGS

1. The PDRR phase provides a well-defined path to an operational system exploiting the currently most mature COIL technology.
2. The PDRR aircraft will be required for several years after the ABL reaches an initial operational capability to continue capability growth of the ABL system in addition to operational concept development.
3. An initial capability could be fielded by 2010.
4. ABL has the potential to contribute to multiple missions in addition to the theater missile defense boost-phase intercept, to include enhanced range theater missile defense link-up through the EAGLE relay mirror constellation (described in Chapter 2), aircraft self-defense, launch site location, impact point location, imaging surveillance, and cruise missile defense.
5. A robust continuing technology effort is required to realize potential capabilities.

SPACE BASED LASER

The Space Based Laser (SBL) is an element in the ballistic missile defense strategy to achieve an effective, global ballistic missile defense capability. SBL is currently envisioned to be a constellation of orbital laser weapons capable of engaging and destroying several classes of missiles, launched from anywhere in the world, during the boost phase. Additional longer-term options that have been considered involve combinations of orbiting lasers, space-based mirrors, airborne lasers, and ground-based laser facilities.

With projected capabilities, an operational SBL would add greater flexibility and effectiveness in response to growing missile threats. Its boost-phase intercept role could be critical in negating attacks employing missiles with nuclear, biological, or chemical warheads.

The SBL project has been restructured several times while efforts continued to move component technologies towards maturity. Currently, the expected deployment period for an operational SBL is two decades away (post-2020). Given this time frame and the continuing evolution of laser technology, the Global Energy Projection study and other advisors have recommended that the actual weapons concept remain flexible at this point. The Ballistic Missile Defense Organization (BMDO) has conducted a number of studies—most recently, the ongoing BMD System Architecture Study (BMD SAS)—supporting the utility of a moderately sized, hydrogen fluoride (HF) laser system in a multi-tier BMD system.

There has been no decision to pursue development of an SBL operational system.

The next major milestone in the SBL project plan is the Integrated Flight Experiment (IFX). This experiment will provide a feasibility demonstration and risk reduction for an operational system that would destroy ballistic missiles in the boost phase. The on-orbit experiment will address system integration of a high-energy laser, a beam control subsystem, and the beam director in the absence of gravity and terrestrial disturbances. An on-orbit experiment is also expected to provide an opportunity to investigate possible SBL contributions to other tasks such as surveillance and reconnaissance, tactical warning, target designation, space object tracking and identification, counter-space, and counter-air.

SBL IFX DEMONSTRATION

The SBL IFX is to include a cylindrical hydrogen fluoride, megawatt-class laser with a 2.4- to 4.0-meter-diameter primary beam director and an integrated beam control system as depicted in Figure 7. Significant ground tests are planned to reduce SBL subsystem and integration risk through the accelerated development and integrated ground demonstration of first generation components: laser, beam control, beam director, and acquisition, tracking, and pointing subsystem. The IFX effort is to culminate in demonstration of the end-to-end capability to acquire, track, and destroy a boosting ballistic missile with a laser from space, as illustrated in Figure 8.

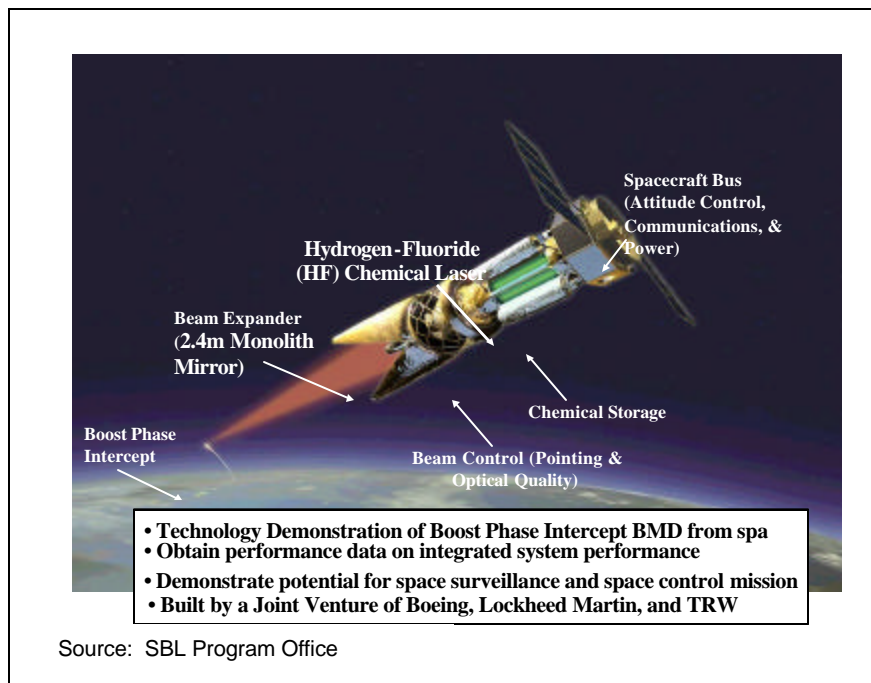

Figure 7. Notional SBL Concept: Integrated Flight Experiment

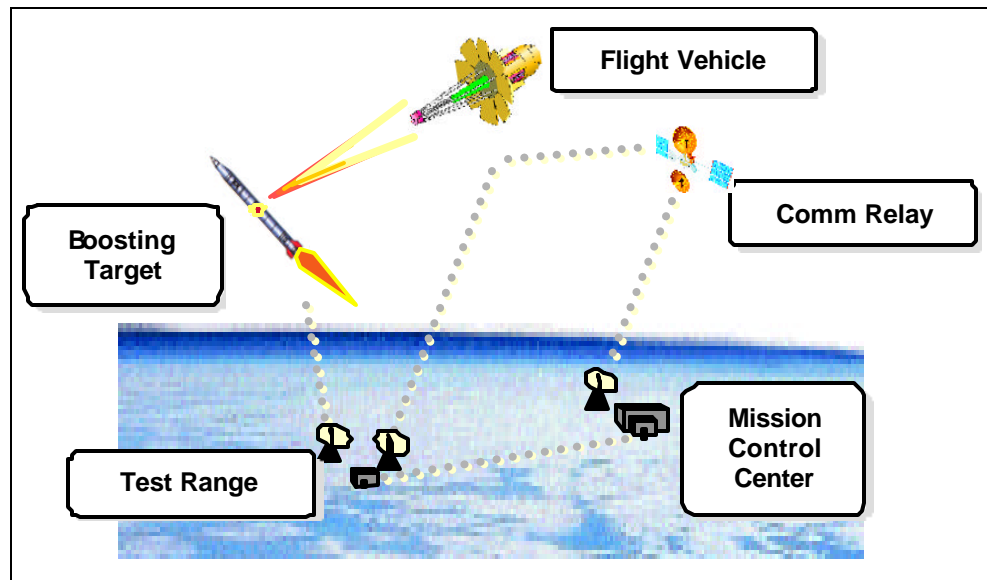

Figure 8. IFX Configuration

Requirements

Because the SBL IFX is a demonstration project, no formal mission needs statement (MNS) or ORD currently exists. However, Capstone Requirements Documents exist for Theater Missile Defense and National Missile Defense (NMD), both of which are applicable to SBL. In addition, requirements guidance for an SBL operational system appear in the Theater Missile Defense, National Missile Defense and Space Control MNS, and more specifically for IFX, in an SBL IFX Objectives Document signed in August 1999. SBL is to contribute to the mission need for “NMD engagement forces for boost-phase intercept, with adjunct mission application potential towards the needs of:

- “TMD engagement forces at long stand-off range”
- “neutralize enemy air defenses”
- “improve precision of munitions delivery”
- “improve range and reduce risks for target engagement”
- “improve space surveillance responsiveness and effectiveness”
- “improve theater fixed target ISR”
- “provide offensive counter-space capability”
- “provide defensive counter-space capability”

Capability Assessment

A definitive capability assessment for the SBL system, given the current threat and current BMD architecture, has not been completed. An initial High Energy Laser Affordability and Architecture Study (AAS) to define the most promising operational space HEL concepts was completed in Spring 2000, and updates will be performed periodically throughout the IFX schedule to address changing technologies and threats. In conjunction with other BMDO studies such as BMD SAS, the AAS process evaluates the specific requirements to be met by a future space HEL system and addresses traceability of the SBL IFX to a future operational system.

Schedule and Funding

The SBL IFX is scheduled to launch in about 2012. The SBL Board of Directors has directed that the trade space be opened to rebalance project risk, cost, and schedule, and that effort continues. The schedule and cost shown in Figure 9 could be affected by those results.

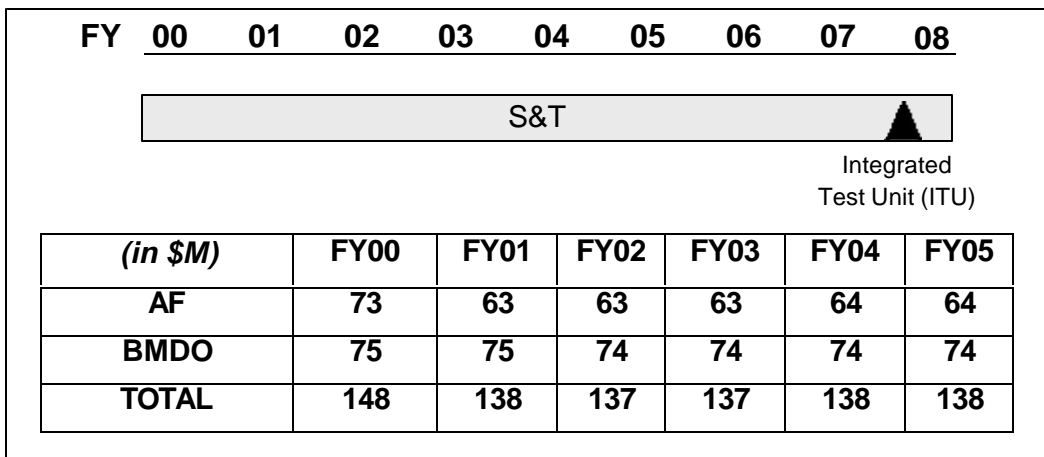

Figure 9. IFX Schedule and Funding

THE PATH TO AN OPERATIONAL SYSTEM

The IFX demonstration is an important step toward an operational SBL system. As shown in Table 1, the project office has identified 12 issues that can be adequately addressed only with in-flight experimentation. An additional issue is the need for large, lightweight deployable optics to reduce the required fairing size and launch weight for the operational system. The deployable optics demonstration has been moved from the IFX to a separate experiment to reduce the IFX risk. Even so, the IFX incorporates multiple high-risk elements, as indicated in Figure 10.

Table 1. Lessons Learned Only in Space

- Find unknown unknowns
- Reliable, remote operation of HEL in space
- Low-jitter line-of-sight control with HEL on same platform as primary mirror
- Bus-payload interactions (e.g., beam expander isolation in space)
- Space demonstration of SBL ground-object imaging/laser designation
- Long-term laser and optical coating survivability
- Actual destruction of ballistic missile in boost phase (smoking gun)
- Contamination control in real space environment
- Sensor operation in radiation environment
- Space-to-ground wavelength band optimization for tracking/negation of fast-burn missiles
- Threat signatures/background data in real environment
- Plume-to-hardbody handover/aimpoint selection/maintenance in real space environment
- Component life in radiation environment

Source: Ballistic Missile Defense Organization

The current IFX plan is to address all the issues in Table 1 in a single on-orbit mission. The list of high-risk elements in Figure 10, along with all other elements of the first on-orbit experiment, suggest that serious consideration be given to several smaller, less risky on-orbit experiments preceding the lethal demonstration. It is particularly important that the experiments provide the information needed to design the operational system.

Figure 11 illustrates part of the challenge in moving from the IFX phase to the operational system postulated for the initial operational capability. A goal (desired) system is identified which provides performance margin for a moderate range engagement against a representative target. The point-of-departure design is still changing as design trades progress toward a System Design Review in fall 2001. Weight trades and other design considerations will affect the performance allocated to these parameters.

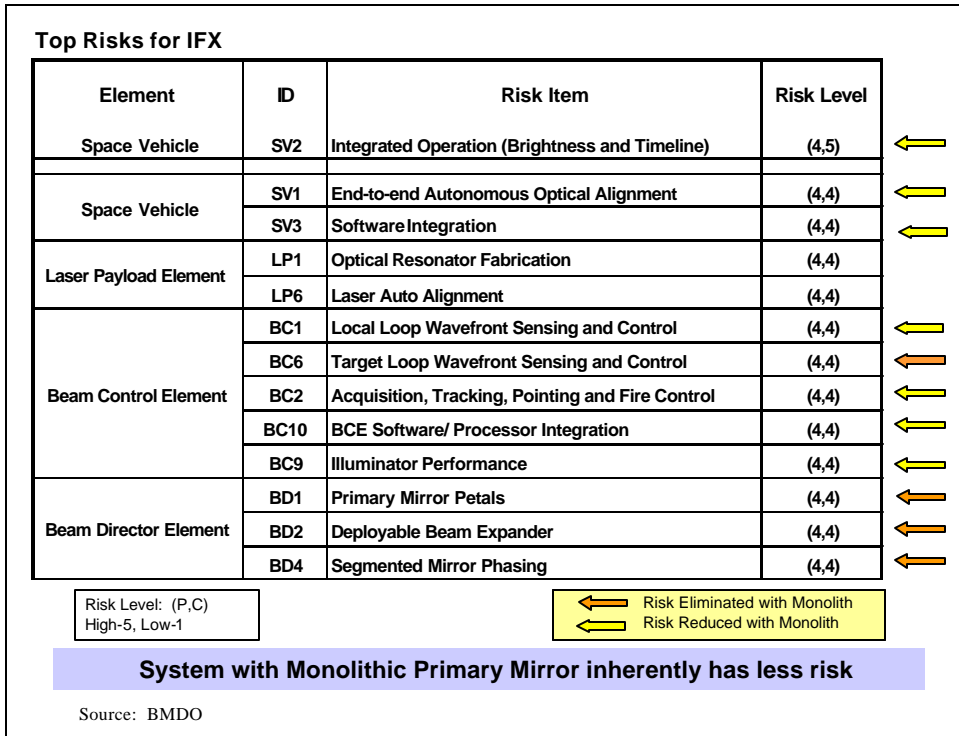

Figure 10. IFX Risk Comparison: Monolithic vs. Deployable Primary Mirror

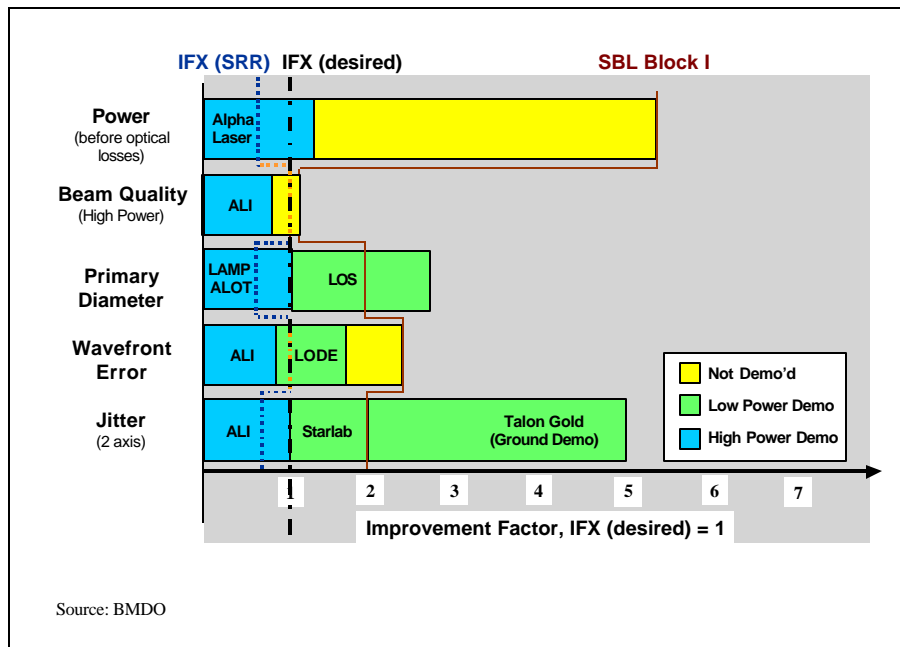

Figure 11. From IFX to SBL Block 1

As indicated in Figure 11, moving from the planned IFX to the initial operational system requires a five- to eight-fold increase in laser power as well as improvements in beam quality, primary diameter, wavefront error, and jitter control. Technically, the most challenging growth in capability required appears to be in beam control and jitter control. Although significant progress has been made in component technology and ground-based laboratory integration, the step to space for some of these technologies will almost certainly require multiple on-orbit experiments. It might be prudent to start planning now for a series of such experiments designed to provide the fastest, most reliable path to a useful operational capability.

A number of approaches can provide global boost-phase-intercept capability using directed energy; these approaches involve various combinations of space-based lasers, air-borne lasers, ground-based lasers, and space-based mirrors (SBM). Each has its advantages and disadvantages. The current assessment by BMDO is that a Hydrogen-Fluoride fundamental space-based laser constellation is the most cost-effective. The AAS suggested that the most cost-effective system might be SBLs and SBMs. Hybrid systems consisting of SBM, SBL, ABL and GBL were found to be more costly for the same level of “design-to” mission performance as a SBL/SBM system since they required the same SBL/SBM constellation, plus additional hybrid elements. There was no further evaluation of Hybrid systems during the study to explore potential performance advantages in non-BMD mission areas, which might offset the additional cost.

Based on existing, demonstrated component maturity and postulated extensions of technology development, a proposed initial operational design would use an 8-10 meter monolithic or segmented mirror and would have a launch weight of some 80,000 pounds. However, planned U.S. launch capability will not accommodate an 8-meter fairing or an 80,000-pound launch weight. Deployable optics are needed to bring the beam director diameter within currently defined launcher limits and could be instrumental in bringing the weight down by permitting a reduction in the laser power requirement. Further technology development would be required to realize those benefits.

Figure 12 lists some of the options for resolving these size and weight issues.

Issue: No Operating System Concept Exists Which Fits Within Payload of Current Launch Vehicles

Family of Possible Solutions

- Develop Heavy Launch Vehicle
 - Low Technical Risk, Relatively Low Cost
 - Addresses All Issues
- Multiple Launch
 - On-Orbit Docking & Assembly
 - Addresses Launch Weight Issue
- Deployable Optics
 - Addresses Fairing Size Issue
- On-Orbit Servicing
 - Addresses Magazine & Lifetime Issues As Well As Launch Weight

A BALANCED PROGRAM WILL EXPLORE EACH OF THESE

Source: BMDO

Figure 12. System Packaging Tradeoffs

SCIENCE AND TECHNOLOGY ISSUES

Among the many SBL technical and programmatic issues is whether the beam of the HF laser can be corrected by a beam compensation system. The output of such a laser has multiple spectral lines at different wavelengths. Apparently, current experience is that projected spot sizes from some such devices are four times the angular area of a theoretical diffraction-limited device. If uncorrected, this would result in a four-fold reduction in the power intensity that can be placed on a target. There remains a question as to the feasibility of correcting the output beam of a high-power HF laser to near diffraction limits using current high power adaptive optics technology. Work is planned over the next 18 months to address this vital question. Negative results could fundamentally alter the path to an operational system by forcing a different approach to providing the laser power.

Technologies Needed For An Operational System

Technology development is needed for:

- The SBL IFX experiment.
- Initial deployment of an SBL system.
- Follow-on systems or upgrades to the initial system.

For the SBL IFX, the need to demonstrate the viability of correcting the beam quality of a multi-line laser, as discussed above, is a key technology need. Other issues fall generally into the category of system integration, as indicated in Figure 13, which is the main purpose of the IFX experiment. A rigorous series of tests must be conducted on the ground to show the feasibility of achieving needed performance in beam control, jitter, and other critical areas.

	Subsystem SOA	Integration IFX System	Threshold System	Advanced Concept System	Technology Goal System
Wavelength (μ)	2.70	2.70	2.70	2.70	1.35
Power (PO)	1	0.67	6.5	10	6.5
Diameter (m)	4	2.4	8	10	8
Jitter (AE)	3.33	1	0.4	0.33	0.17
Wavefront Error (WFE) (WE)	2	1	0.63	0.45	0.2
Brightness (BR)	3×10^{-4}	0.01	1.50	4.10	8.10

Significant performance increases are needed in all technologies

- From current state-of-the-art (SOA) to IFX
- And from IFX to Operational System

Source: BMDO

Figure 13. Requirements for SBL System Performance Have Strong Technology Implications

Technology needed to scale from the IFX “system” to an initial operational system must also be addressed. Those technologies that are driving requirements for SBL should be managed within the SBL program. These include critical components such as advances in conventional adaptive optics, wavefront sensing techniques, and large optics. Approaches to packaging the satellite for deployment also fall into this category.

Technology development for follow-on operational systems, which also needs to be considered, is currently the most immature. Since these technologies represent long-term development, it is not possible to know which efforts will achieve the levels needed to realize advanced concepts. Much of this technology development should be pursued under an S&T program and transferred into the SBL project as the technology matures. Candidates include:

- *Beam Control (wavefront error and jitter).* Research should include non-linear optics phase conjugation, inertial reference units at low noise and high bandwidth, and other components such as low noise sensors, deformable mirrors, illuminator lasers, and coatings.
 - *Wavefront Error Correction.* Both conventional adaptive optics and non-linear optics techniques offer promise, in different time frames. In addition, a “best” wavefront error control concept needs to be established.
 - *Pointing Jitter Correction.* The SBL project requires an inertial reference unit at low noise and with high bandwidth. There is also a need to demonstrate active tracking on boosting missiles at long range. The ABL program is scheduled to do this in the near term.
- *Deployable Optics.* Development of large optics and relay mirrors could be pursued in collaboration with related efforts at the National Aeronautics and Space Administration (NASA) and the National Reconnaissance Office (NRO). Related development areas include active structural control and vibration isolation.
- *High-Energy Lasers.* A number of technology development areas relating to the lasers themselves should be explored including: short wavelength lasers as an option for HEL devices, modeling and simulation of detailed systems concepts, and anchoring to experimental data including those from the Alpha device. At least four short-wavelength options can be pursued in technology competition—hydrogen fluoride overtone (HFOT) lasers, space-based chemical oxygen iodine lasers (SB-COILs), all-gas iodine lasers, and solid-state lasers (SSLs).

The Affordability and Architecture Study suggested a time-phased technology development plan for the SBL, as illustrated in Figure 14. Funding available today is well short of AAS projected requirements in all technology areas, with the largest shortfall in chemical laser device technology. Considerable work is required to implement a technology development plan that can be effectively executed. The section below addresses several elements of managing a science and technology program for SBL.

AAS Technology Development Plan Suggested a Time-Phased Program was Required

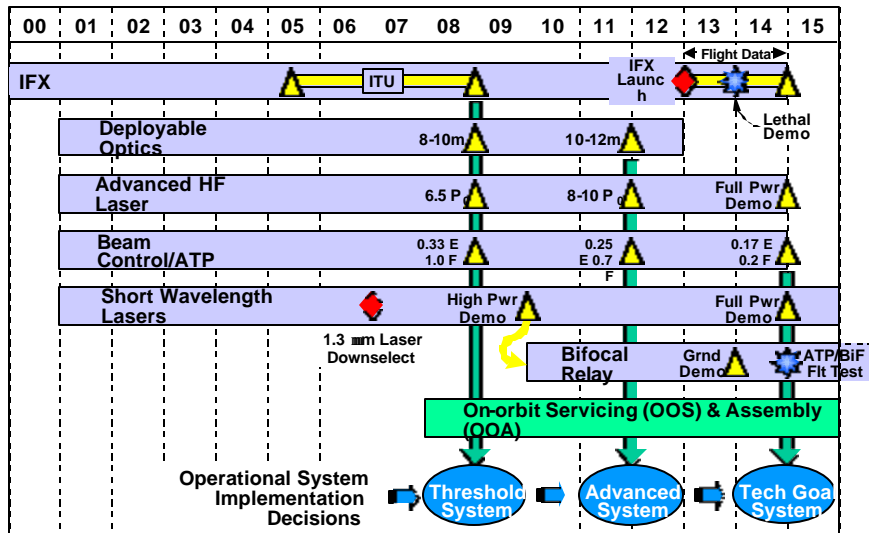

Source: SBL Program Office

Figure 14. SBL Technology Development Plan

Managing An SBL Technology Program

An SBL advanced technology program would be distinct from the flight experiment project, but managed in tight concert with the SBL project office. For advanced laser candidates, the program must address all aspects of operational SBL system requirements as noted above.

The technology development program should explore competing approaches in each technology area, with well-defined off-ramps and decision criteria. Figure 15 illustrates a technology development approach to short-wavelength lasers. The approach allows for parallel research into both HFOT and COIL (among other technologies), which would lead to a down-selection after six years. There are specific milestones included, which constitute “go/no-go” decision points. That is, if a particular technology line were unlikely to be able to meet its demonstration objective, then it would be abandoned in favor of other options.

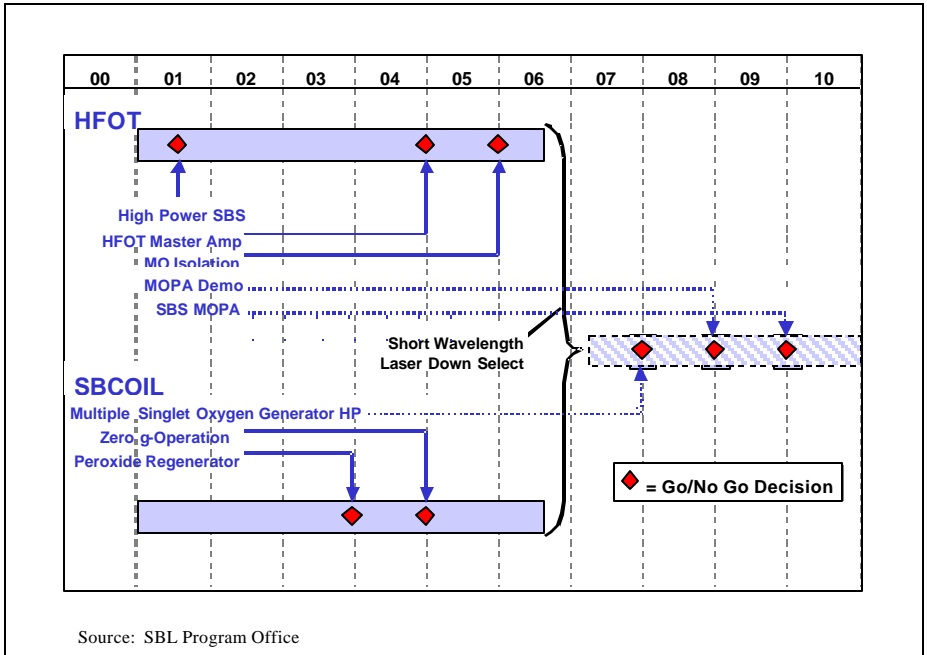

Figure 15. An Example of a Short-Wavelength Laser Technology Development Roadmap

A similar approach for beam control technology development is illustrated in Figure 16. The difference here is that there are no “go/no-go” decision points, but rather, performance demonstrations that affect decisions on which type of laser device technology should be pursued. In addition, there is a focus on specific beam control component developments including inertial reference units, deformable mirrors, fast steering mirrors, tilt sensors, wavefront sensors, processors, and illuminators. In this case, parallel research efforts in jitter reduction, wavefront error reduction, and acquisition, tracking, and pointing (ATP) development would culminate in an integrated beam control test.

Figure 17 illustrates the importance of ongoing technology development in beam control areas by emphasizing that there are numerous approaches to performing the beam control function. At the top left, a relatively simple SBL design shows that only one deformable mirror (DM) and one fast-steering mirror (FSM) are needed to correct the outgoing beam. The outgoing wavefront sensor (OWS) measures the outgoing beam directly, and corrects the wavefront to look like a calibration wavefront obtained through star measurements. The top right is a slight generalization that includes a local loop in addition to the basic design.

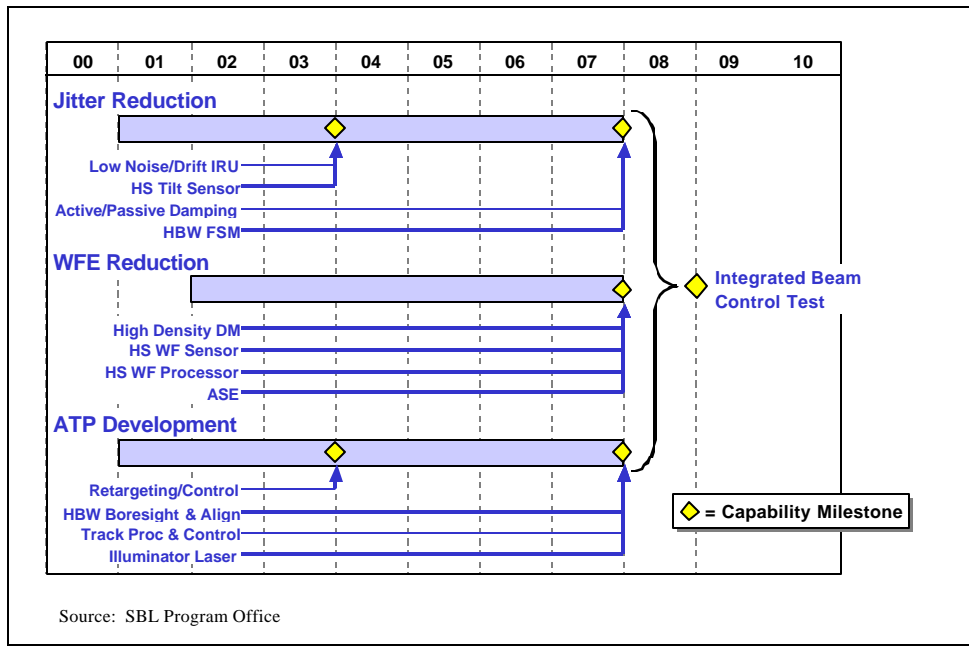

Figure 16. An Example of a Beam Control/ATP Technology Development Roadmap

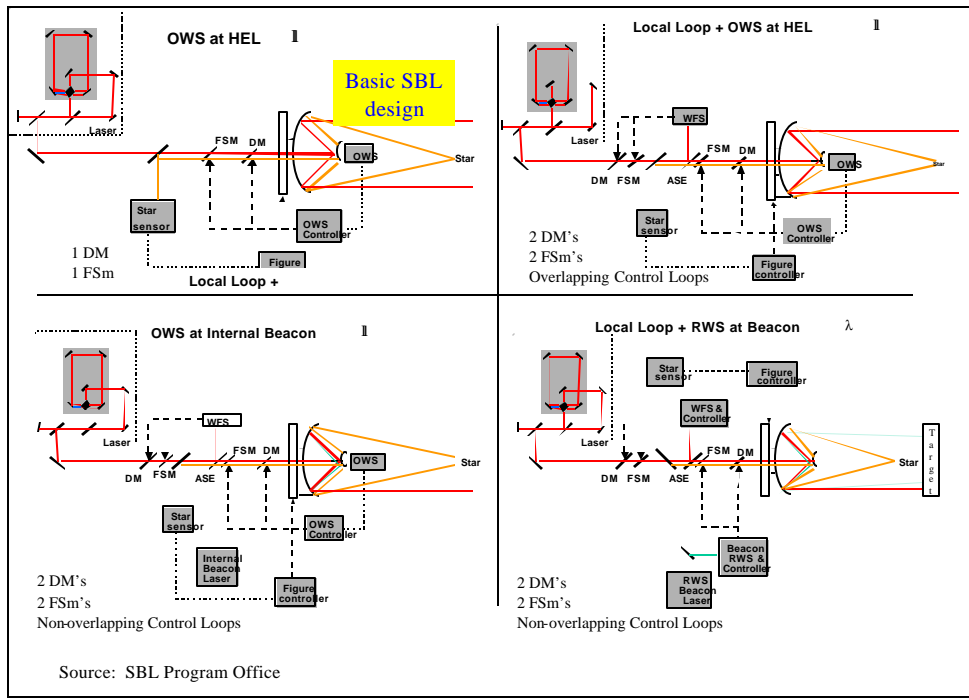
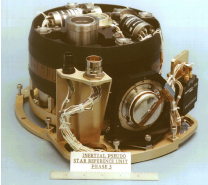
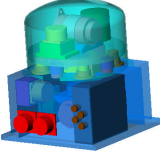

Figure 17. Multiple Beam Control Concepts Make for Possibly Different Technology Investments

The lower left part of Figure 17 shows a more complicated system that uses a surrogate laser to sense and correct the target loop optical path, while still using the local loop to correct any HEL aberrations. Finally, the lower right dispenses with an outgoing wavefront sensor altogether, replacing the target loop optical sensing with a return wave sensor (RWS) using beacon return from the target in a manner similar to the ABL program. It is not clear at present which of these concepts is best for an SBL system or if another system using inertial reference units (IRU) to provide local loop stabilization is better.

Figure 18 illustrates the issue of inertial reference units. In the past, developed technology existed that could perform adequately for an operational SBL. This is no longer the case today. Current IRU sensors are adequate for an IFX, but not for an operational SBL.

A proposed, but unfunded, technology development effort for large, deployable optics is illustrated in Figure 19. This effort would lead to a ground demonstration for 10-meter deployable optics, with the goal of maturing capabilities to use in the EMD system.

- Circa 1990, SDIO/HABE/SBL program: Draper Labs
- Demonstrated LOS stability of $\ll 50$ nanoradians (nr)
- Very benign environment (isolated lab with simulated space craft "vibration loads")

- SVS SIMMS Tactical IRU demonstrated, $1\mu\text{r}$
- ATA Tactical IRU developed under SBIR
- Lockheed's IRU for ABL delivery due in February, 2001, with approximately 150 nr line of sight stability required

Inertial Reference Unit State of the Art

- Existing inertial instruments can meet IFX needs but not operational needs
- Fiber-optic gyros show promise for future
- No inertial instrument development programs exist which support large-aperture precision pointing requirements

Source: SBL Program Office

**Figure 18. Outgoing Wavefront Beam Control Technologies
Need Inertial Reference Units**

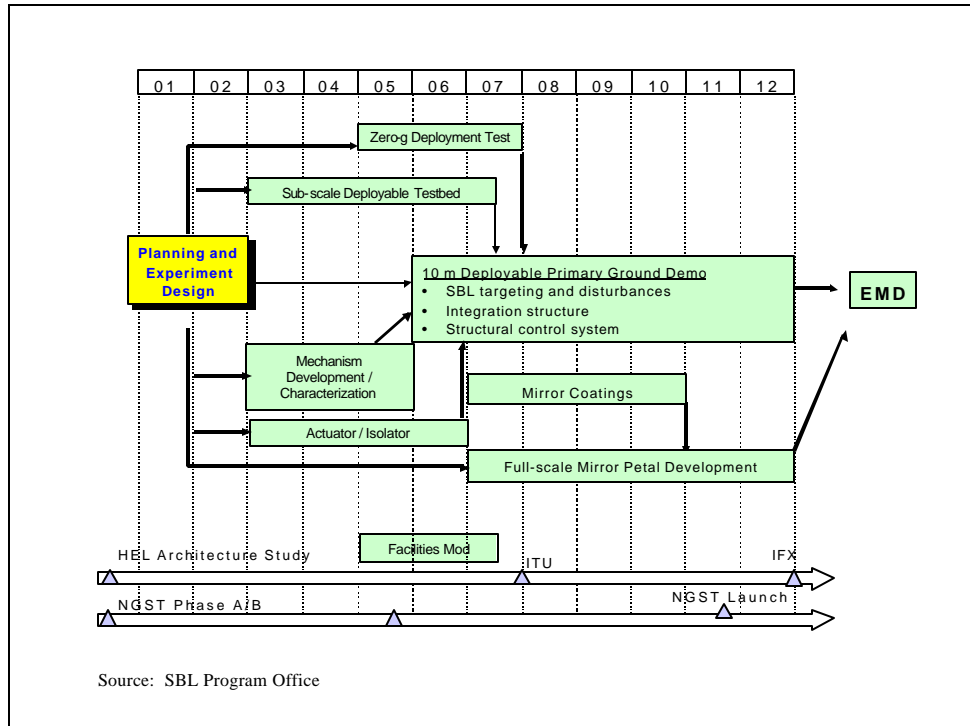

Figure 19. An Example Technology Development Roadmap for Large Deployable Optics

The relay mirror technology development effort is not currently funded but is another example of parallel technology development that could lead to an improved SBL capability. The concept for a relay mirror demonstration would involve pursuing each of the laser technologies. The prototype system would demonstrate power levels within 4 times the operational requirements. Laboratory demonstrations should be within another factor of 4 times the prototype. The result is that power levels should be $\sim 1/16$ of the operational requirement.

The candidate set of laser devices will narrow prior to a PDRR system decision as a result of down-selections or failure to show continued improvement. The laser device technology funding lines should include some beam control work, shown in Figure 20, such as non-linear optics in the HFOT schedule. Beam control components include large focal plane arrays, deformable mirrors (including industrial base robustness), illuminators, coatings, windows, and holographic gratings, at a minimum. The demonstration programs could include space experiments, which may be needed for the selected HEL device concepts and also for relay mirrors or deployable optics.

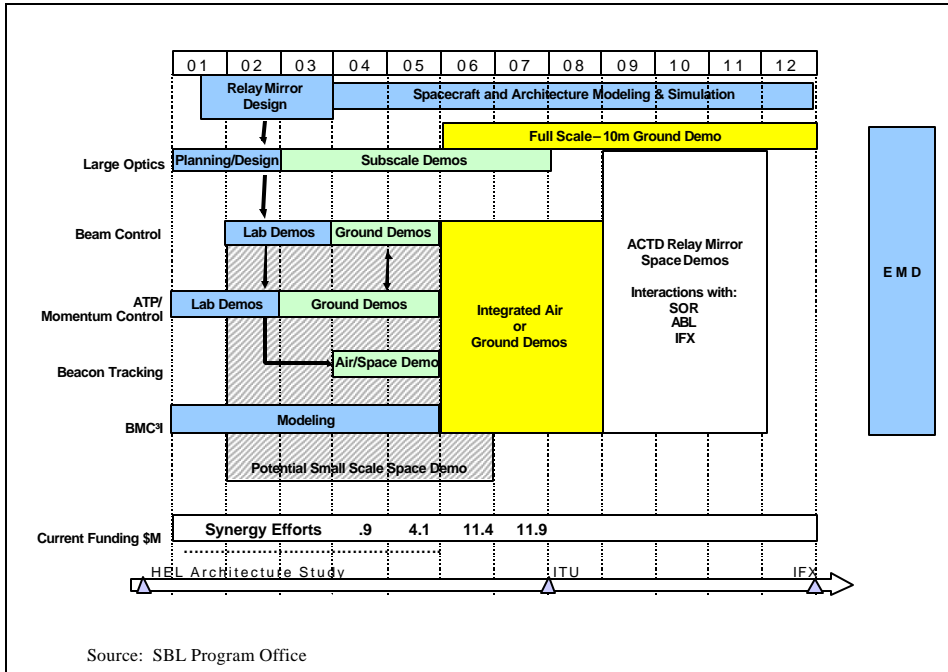

Figure 20. An Example: SBL/AFRL Relay Mirror Technology Development

BMDO agrees that most of the suggested technologies are worthwhile investments for future HEL systems, but should not be part of the SBL project until their feasibility is shown. History has shown that this will require many years.

BMDO believes it is premature to consider a relay mirror experiment for the high-power BMD missions. On the other hand, studies consistently show an advantage from relay mirror concepts, from both a cost-effectiveness and multi-mission capability. The task force feels that a space-based mirror capability should be demonstrated.

Funding an SBL Technology Program

A robust technology development plan, as described above, would require significant funding levels for the next decade—totaling \$1.4 billion. Figures 21-24 array the funding requirements in the three functional areas described: laser devices, beam control, and large optics. The largest amount of funding is needed in the area of laser devices, followed by optics and beam control. As Figure 24 illustrates, most of the early funding is in exploratory development, the 6.2 budget category, on the assumption that producing an early operational capability requires rapid advancement of mostly existing technology. But over time, the largest portion of funding should be devoted to technology

demonstrations, in order to reach an operational capability. Only a small portion of funding, in the early years, is devoted to basic research.

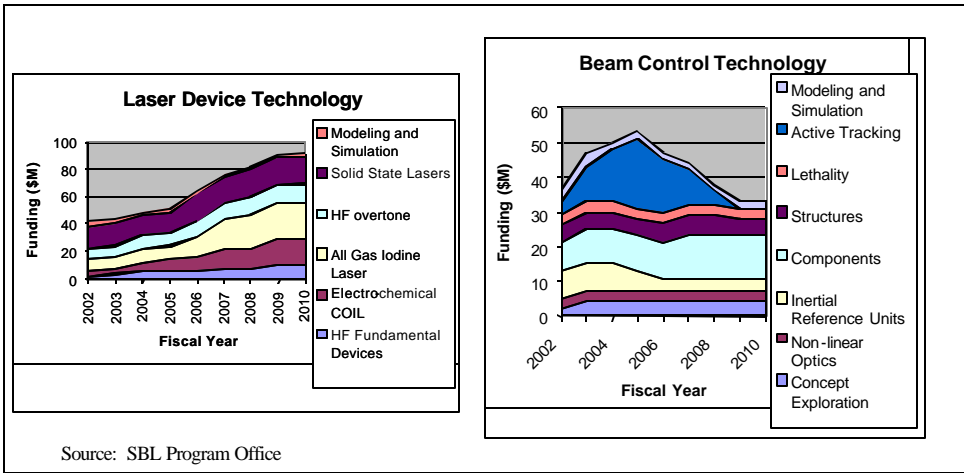

Figure 21. Technology Development Plan Requires Significant Funding Levels Over 10 Years

Year	Proposed Technology Plan (\$M)										Total
	2001	2002	2003	2004	2005	2006	2007	2008	2009	2010	
Laser Devices	0	42	44	49	51	64	77	82	90	91	590
Beam Control	0	37	47	50	53	47	44	38	33	33	382
Large Optics	0	12	23	33	40	40	66	63	63	60	400
Technology Totals	0	91	114	132	144	151	187	183	186	184	1372

Source: SBL Program Office

Figure 22. Technology Development Plan by Function

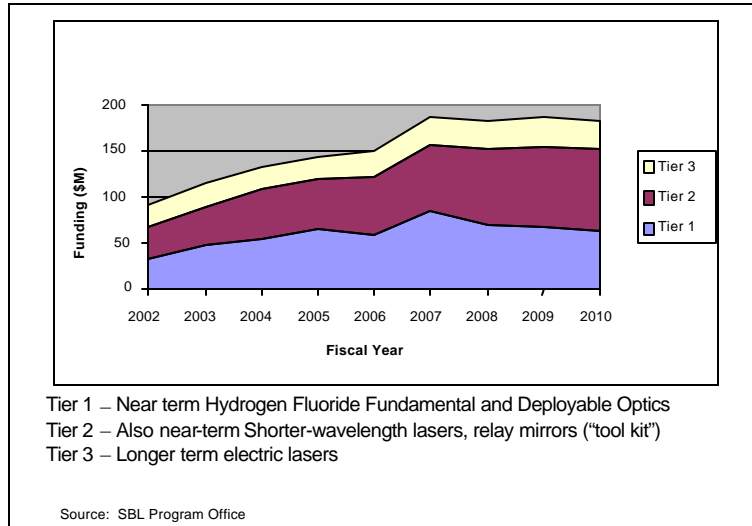

Figure 23. Technology Funding by Tier

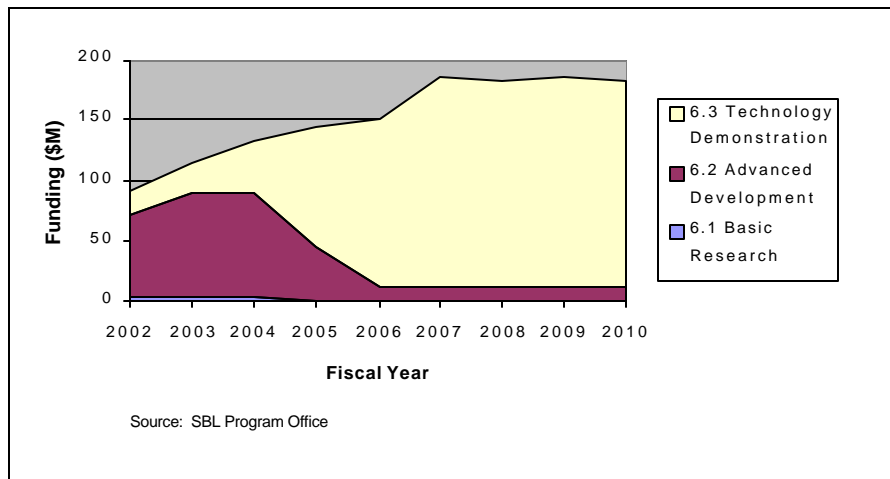

Figure 24. Technology Funding by Budget Category

TASK FORCE FINDINGS

1. The project office has identified 13 specific issues that require experiments in space to develop or validate design information. Several of these are identified as high-risk elements by the project office.
2. The current IFX plan is to address 12 of the 13 issues in a single, first IFX in space. This produces an IFX with multiple high-risk elements. One significant issue—deployable optics—is to be addressed in a separate part of the program consisting principally of sub-scale and full-scale ground demonstrations. Currently deployable optics research is not funded.

3. Based on existing, demonstrated component maturity and postulated extension of technology development, a proposed initial operational design would use an 8- to 10-meter monolithic or segmented mirror. The system would weigh some 80,000 pounds.
4. There is no planned U.S. launch vehicle that could accommodate either an 8-meter fairing or an 80,000-pound payload, though there are design studies for such a system.
5. Deployable optics could bring the fairing size within planned capabilities of the U.S. heavy launch system and allow deployment in two segments with on-orbit assembly or possibly in a single segment if weight could be sufficiently reduced.
6. Both options require significant science and technology efforts, which are not currently funded.
7. The performance growth from IFX to an operational system defined in the SBL Affordability and Architecture Study requires significant scaling in laser system performance. Specifically, there is a 5- to 8-fold increase in laser power, a 2- to 3-fold increase in aperture diameter, a 2-fold improvement in wavefront error correction, and a 2- to 3-fold improvement in jitter correction. A funded SBL technology program is needed to provide these performance improvements. Delaying this technology program until after the IFX program is completed will significantly delay any operational capability.
8. A robust S&T program is needed to provide alternative space-qualified HEL sources for an operational SBL, involving short-wavelength lasers such as hydrogen fluoride-overtone, space-based COIL or other iodine lasers, or solid-state lasers.
9. An extensive continuing development program is needed to mature system capability for insertion beyond an initial operational capability. Potential development paths include closed-cycle chemical lasers, electrically driven lasers, and beam quality compensation.
10. Though the current architecture studies conclude that space-based systems out-perform ground-based and space-based relay mirrors, these results are highly dependent on the underlying assumptions. A balanced long-term technology investment is needed for space-based lasers, ground-based lasers, and space-based relay mirrors.

HIGH ENERGY LASER SYSTEM – TACTICAL ARMY

The High Energy Laser System – Tactical Army (HELSTAR) is envisioned as a far-term Army HEL system. The HELSTAR concept is for a multi-platform, multi-mission system, which can be tailored to threat and force package requirements. The HELSTAR is intended to serve as the HEL component of the Army's Enhanced Area Air Defense (EAAD) system—a primary driver in HELSTAR's development. The Army is also exploring the potential for HELSTAR to grow to meet other future needs, such as those envisioned for the Objective Transformation Force. These needs may include space control, special operations (ultra-precision engagements), military operations on urban terrain, countermine operations, destruction of unexploded ordnance (UXO), improved survivability of ground and air systems against precision-guided munitions, destruction of enemy reactive armor, and the suppression of enemy air defense (SEAD). HEL systems offer the potential for new and improved warfighting capabilities that can be exploited across this broad spectrum of missions.

EAAD is an evolving requirement for an Army air and missile weapon system to provide military commanders multiple capabilities using advanced directed energy and/or kinetic energy technologies, mounted on common Army platforms. EAAD is an integral part of the Army Air and Missile Defense transformation strategy, part of the overall new Army Vision. EAAD is to have the combined capability to negate a primary threat set that includes large-caliber rockets, mortars, artillery projectiles, and unmanned aerial vehicles that are providing the enemy long-range reconnaissance and surveillance intelligence. EAAD will also have the capability to cost-effectively counter a secondary threat set consisting of cruise missiles, fixed and rotary wing aircraft, air-to-surface missiles, and tactical ballistic missiles that have “leaked” through other types of air and missile defense systems.

On May 12, 2000, the Joint Requirements Oversight Council (JROC) validated that EAAD falls within the scope of the Joint Theater Air and Missile Defense Mission Need Statement. The JROC recommended the Under Secretary of Defense for Acquisition, Technology, and Logistics initiate Milestone 0 concept exploration and designate EAAD as a potential major defense acquisition program with joint interest.

DEMONSTRATIONS

The Army is pursuing two primary demonstrations for HELSTAR: the THEL/Mobile THEL (MTHL) demonstration and the solid-state laser technology demonstration program. In addition, a small technology effort

is ongoing to develop a Fuels Regeneration System (FRS) for an electrochemical chemical oxygen iodine laser (EC-COIL). Each of these demonstrations is discussed below.

THEL

Objectives. The overall objective of the THEL program is to demonstrate and test the ability to integrate the laser, pointer-tracker, and command, control, communications, and intelligence (C3I) subsystems into a weapon capable of acquiring and tracking targets, pointing the laser beam, and delivering sufficient power to destroy threat rockets in flight. The Army Space and Missile Defense Command (SMDC) is the executing agent for the Joint U.S./Israel THEL Advanced Concept Technology Demonstration (ACTD) program for the Office of the Secretary of Defense (OSD). The program has been funded through completion of field-testing at the High Energy Laser System Testing Facility (HELSTF) planned for FY 2001. Planning for operational testing in Israel will continue, and the THEL demonstrator will be deployed to Israel as may be required. THEL is designed so that it can be transported to both United States and Israeli sites to verify performance against operational short-range rocket targets.

THEL is composed of the following subsystems:

- Laser subsystem, which generates the high power beam.
- Pointer-tracker subsystem capable of steering the beam such that the system optically tracks threat objects and directs the lethal laser beam to the target.
- Command, control, communication, and intelligence subsystem, which controls and monitors the THEL system; provides battle management, including target acquisition through the fire control radar, engagement control, kill assessment, and communication with other assets; and provides the operator interfaces.

The THEL ACTD hardware has been fabricated by the contractor team and integrated at HELSTF, and it is currently undergoing field-testing. The C3I subsystem, including an Israeli-furnished radar, was tested in Israel and at HELSTF. Completed in January 1999, the C3I subsystem test has demonstrated the capability to track multiple rockets and properly classify them as ballistic targets. The laser subsystem achieved “first light” in June 1999, and before leaving TRW’s subsystem integration and test facility at Capistrano, California, demonstrated near full power.

In April 2000, the high-power beam from the laser subsystem was first propagated through the pointer-tracker subsystem to a static test site. In June 2000, the THEL demonstrator achieved its first successful shoot-

down of a single Katyusha rocket. In August, the THEL system conducted a successful (sequentially launched) multiple rocket shoot-down. This was the first successful engagement of multiple airborne targets by an HEL system. This engagement was subsequently duplicated in September 2000 with the more stressing challenge of destroying simultaneously launched rockets.

Path to Operational Capability. MTHEL is a cooperative program between the United States and Israel, as a follow-on to the THEL ACTD. While MTHEL will emphasize satisfaction of the Israeli requirements, it will also consider emerging U.S. requirements related to EAADS. The major emphasis of this program is to reduce the size of the THEL ACTD system to a more compact and mobile operational version of a deuterium fluoride (DF) chemical laser. MTHEL is projected to have improved capability over the THEL ACTD demonstrator in a number of areas: it should eliminate the need for concrete structural pads, improve transportability, reduce deployment time, reduce system cost, and increase operational availability. An MTHEL System Engineering Trade Study, which will lay the foundation for follow-on development activities, has been authorized by an amendment to the United States/Israel Memorandum of Understanding. The details of the future MTHEL program will be determined during this study.

Solid State Laser

Objectives. The objective of the SSL demonstration technology program is to develop a lightweight, high-average-power, high-pulse-energy SSL that is suitable for a variety of short-range and time-critical air and missile defense missions. The solid-state heat-capacity laser (SSHCL) is the specific solid-state laser technology chosen for this program. Because of its expected compact size, the SSHCL has the potential to be mounted on either a ground-mobile or airborne platform. Since the SSHCL is an electrically driven laser, a hybrid-electrical ground vehicle is ideally suited to carry it, since the same prime power source can serve to provide both the propulsion of the vehicle and power to the laser. Because of its pulsed beam format, the SSHCL offers the possibility of new lethality mechanisms, based on structural damage to the target.

The SSHCL was approved during FY 2000 as an Army Science and Technology Objective with the specific development goals described below. In addition, the OSD Joint Technology Office (JTO) approved funding in FY 2001 to investigate a thermal management concept for mist cooling of the Neodymium (Nd)-doped crystal slabs and laser diode pump arrays.

The SSHCL program is based on the solid-state heat capacity laser developed by Lawrence Livermore National Laboratory (LLNL). This

type of SSL operates in a pulsed mode with a typical pulse width of several hundred microseconds and a repetition rate of several hundred hertz. The laser beam is generated from Nd-doped crystal slabs, which are pumped by monolithic, high-duty-cycle, high-exitance diode arrays. Work is currently being done with flashlamp-pumped Nd:glass slabs to support the development of advanced actively-corrected resonators, and to perform initial lethality measurements for basic materials.

A breadboard, using flashlamps in place of diodes, has been assembled and is undergoing evaluation at LLNL prior to shipment to HELSTF for additional performance, lethality, and beam propagation testing. The target for first light at HELSTF is June 2001. Supporting technology has been demonstrated in the laboratory, which includes handling of the heat load by the laser diodes, edge cladding of the disks, crystalline disk manufacturing techniques, and the intracavity adaptive optics wavefront control subsystem.

Based on current funding, the SSHCL Science and Technology Objective is to develop and demonstrate by FY 2004 a 3-disk module SSHCL, pumped by diode arrays and capable of producing 15 KW (>70 J @ 200 Hz). Subsequently, by adding additional modules, a prototype producing 100 KW (500 J @ 200 Hz) is to be developed and transferred to HELSTF by FY 2007 for integration with a pointer-tracker. Laser performance will be evaluated along with lethality and propagation testing.

A 10 KW flashlamp-pumped device has been designed, fabricated, and integrated. This device has demonstrated, over ten seconds, a pulse of energy of 639-560 J at 20 Hz, yielding an average power level of 12.8 KW. To date it has been configured with a stable resonator operating without deformable mirrors. Single pulses have been demonstrated with energies up to 1 kJ. A full-scale adaptively corrected unstable resonator was integrated on the subscale, 3-disk module, which operated at 1.4 KW. The 3 disks were then heated by the flashlamps, thus causing thermal distortions. A low power, probe beam was then injected into the device cavity and propagated through the distorted disks. The probe beam was sensed and beam corrections were made through the deformable mirrors on the unstable resonator. This test yielded an initial beam quality of less than 2X DL and a final beam quality of less than 2X DL after 20 seconds of operation. Subscale device testing infers beam quality of about 2X DL will be achievable on the full-scale 9-disk laser device when the unstable resonator with the deformable mirrors is completely integrated and tested. This includes the full thermal disk distortions expected for the 100 KW laser device.

In parallel with the activation of this 10 KW flashlamp-pumped laser system, technology efforts to develop the diode-pumped device are ongoing. Nd:GGG crystals with boule diameters of 12 cm and Nd-doping

concentrations of .8% have been grown. Also, the first large-scale diode arrays are being constructed using the monolithic cooler architecture. A 200 W array has been demonstrated with a goal of 700 W in 2001. These arrays will be used to pump a sub-scale Nd:GGG crystalline slab as the first experimental step toward the scaling of the 10 KW heat capacity laser system to 100 KW average power.

Path to Operational Capability. A program to fund and develop a vehicle-mounted 100 KW SSL demonstrator weapon prototype compatible with the Future Combat System (FCS) is under consideration by the Army. The SSL demonstrator, utilizing an existing 30 cm beam director, will be fully integrated on a hybrid-electric platform. The system, including all supporting subsystems, will be deployable in a C-130 class aircraft. The system power supply will use an advanced battery, developed by the Defense Advanced Research Projects Agency (DARPA), which should double the current electric storage capacity, and an advanced mist cooling system to reduce magazine reload time.

Electrochemical Chemical Oxygen Iodine Laser Fuels Regeneration System

Objective. The EC-COIL FRS program is a small ongoing technology effort to develop, optimize, and demonstrate the FRS element for an EC-COIL weapon system. EC-COIL continues to be an option for short-range tactical applications using both air- and ground-based platforms. There are two key challenges for developing the EC-COIL weapon system. First, the chemicals involved in the COIL process must be rapidly regenerated without requiring additional reagents or producing undesired byproducts. Regeneration would eliminate or mitigate many system operational issues such as timely resupply of the laser fuels, system availability limitations due to handling and refueling operations, and personnel safety. Also, recycling or fuel regeneration provides greater autonomy for the weapon on the battlefield. The second major challenge is the integration of the chemical processing capability into a compact and flexible package that which can in turn be integrated with a COIL device suitable for conducting assigned operational missions.

The FRS has three key functions: liquid processing, gas processing, and reagent production. Liquid processing separates the chemical products (potassium chloride [KCl] and water) from basic hydrogen peroxide (BHP). It also manages the heating and cooling functions required for COIL liquid systems operation. Gas processing recovers and separates the gaseous exhaust products of the laser, which are collected in the sealed exhaust system (SES). Last, reagent production takes these various waste products and synthesizes the key chemical reagents for the COIL device: potassium hydroxide (KOH), hydrogen peroxide (H₂O₂), and chlorine (Cl₂). Results to date indicate that individually, all of these

processes are feasible and can be performed without the production of significant byproducts. Therefore, it is expected that the COIL fuels can be reprocessed numerous times before needing replacement.

Path to Operational Capability. The initial step under consideration, in moving this technology to an operational capability, is to integrate a ground-based FRS with the COIL device of the Advanced Tactical Laser (ATL) ACTD. The FRS would remain at the forward air base for a rotorcraft-mounted ATL. A mobile FRS capable of being deployed to a forward supply base would be the logical step for a ground-mounted version of the ATL ACTD demonstrator.

SCIENCE AND TECHNOLOGY ISSUES

The overall HELSTAR strategy for developing near-term and objective HEL weapon systems is shown in Figure 25. This strategy offers options for providing this leap-ahead technology to the soldier in the field. Chemical lasers (DF and COIL) are the most mature technologies available, and have demonstrated weapon-level powers. However, they have disadvantages, primarily in their size and weight and the need for logistics supply of hazardous and toxic chemicals. Solid-state lasers offer the promise of a compact configuration and electrical operation, requiring only diesel fuel to resupply a power source (generator). However, SSLs are a higher risk, both in meeting the expected required output power and the necessary duty cycle. Science and technology research is needed in each of these areas to enable a cost-effective operational capability.

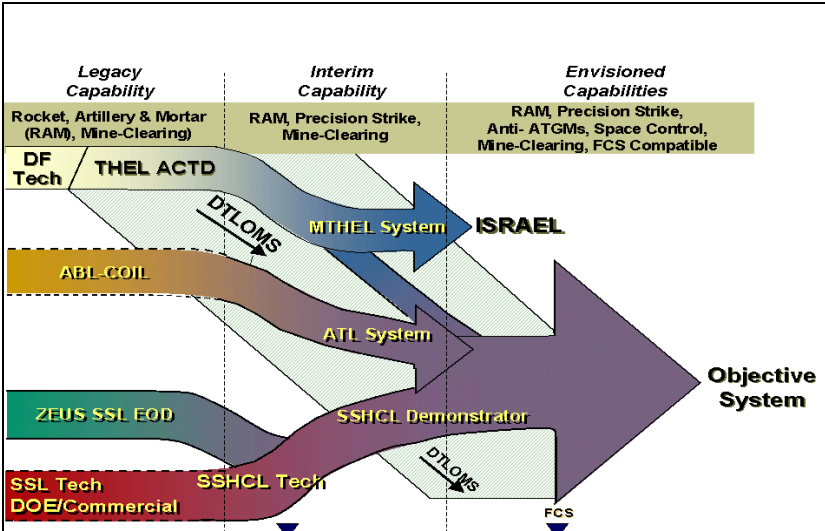

Figure 25. SMDC HEL Development Strategy

DF Lasers

An artist's conception of the transformation of the DF chemical laser is shown in Figure 26. The current technology, THEL, is represented in the lower left picture. MTHEL, depicted in the center, will reduce the size of the system by a factor of five as compared to THEL without reducing the performance. The bullets qualitatively summarize the science and technology challenges of the MTHEL program. The objective DF weapon system is shown in the upper right picture. It is envisioned to meet the EAAD requirements and potentially the integration requirements of the Future Combat System.

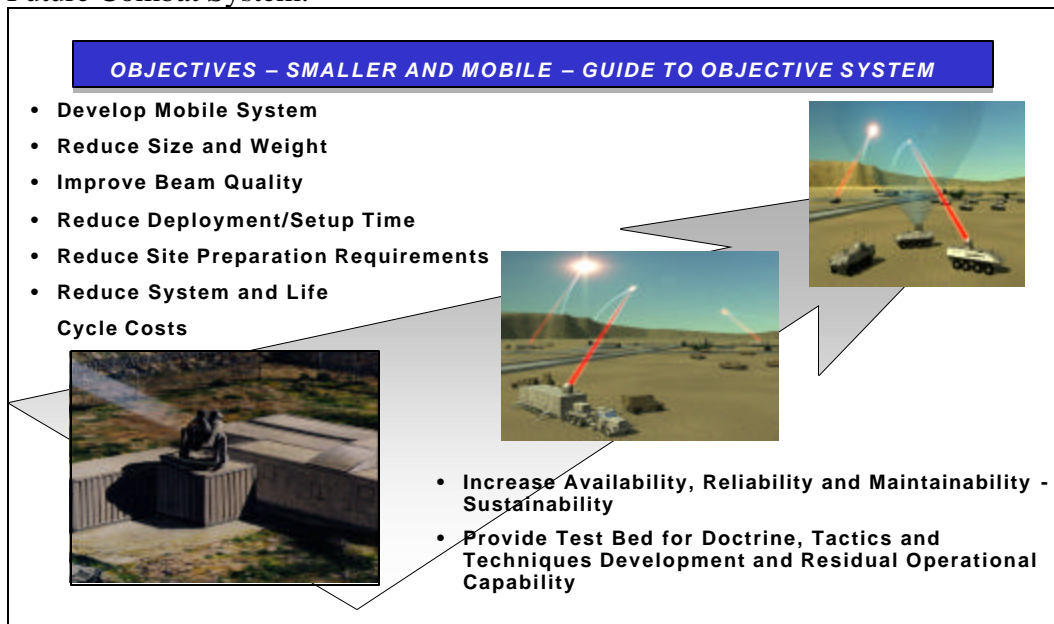

Figure 26. DF Laser Weapon System Development

Solid-State Lasers

The SSL program is envisioned as the primary objective technology to satisfy the EAAD directed energy requirement and will serve as a candidate technology for the FCS-compatible HELSTAR system. Figure 27 provides a summary of the development plan for providing a 100 KW vehicle-mounted demonstrator by FY 2007. The major remaining challenges are to:

- Replace the flashlamps with diode arrays, and integrate the weapons-scaleable components into a high-power prototype.
- Demonstrate effective heat management of the disks and diodes in order to meet evolving operational availability requirements.

- Demonstrate the production of the laser diodes at an affordable price. Diode costs should decrease through a pilot production program and to meet commercial dual-use requirements.
- Determine pulsed beam propagation and lethality against projected airborne threats.

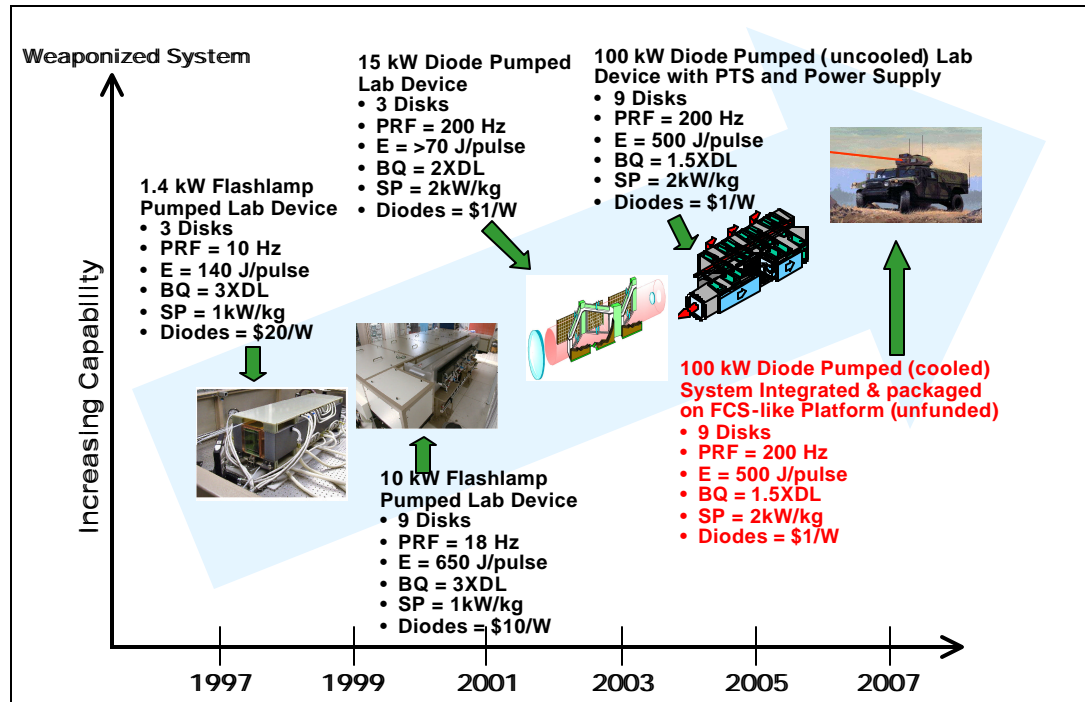

Figure 27. SSHCL Laser Weapon System Development

EC-COIL

For the EC COIL to be an option a closed cycle regeneration system is required and several integrated processes must be cost-effectively demonstrated. The ATL remains one option for this demonstration. In the near term, the following challenges must be resolved:

- Demonstrate an integrated chemical regeneration process and its viability in an operational weapon system. This includes:
 - Recovery and separation of laser gases from the SES.
 - Recovery of KCl and H₂O from BHP.
 - Production of Cl₂ and KOH from recovered KCl and H₂O.
 - Production of H₂O₂ from the recovered oxygen and water or hydrogen.
- Demonstrate an effective thermal management system.

TASK FORCE FINDINGS

1. The THEL ACTD has demonstrated the capability to intercept and destroy Katyusha class rockets as part of a cooperative U.S. DoD-Israeli MOD (USDOD-IMOD) development program. The THEL ACTD has demonstrated the operational feasibility of a complete tactical fire control system coupled to deuterium fluoride laser technology in a transportable configuration. The rockets are a key part of the threat in the Army-envisioned Extended Area Air Defense System ORD (Draft).
2. The Mobile THEL follow-on program will continue the USDOD-IMOD efforts aimed at producing a more compact, mobile version of the DF laser system. The initial study phase will consider comparable EAADS requirements in evaluating alternative designs.
3. A U.S.-only version of THEL—called HELSTAR—is a response to evolving future requirements such as EAADS and the Future Combat System and is under consideration. Alternative laser technologies—the solid- state heat capacity laser and the electro-chemical COIL—are part of the long-term set of alternatives.

CHAPTER II. NEW APPLICATIONS

As technology matures, the operational potential of high-energy laser systems on the battlefield will grow. This chapter describes a number of promising concepts for HEL systems and the role they could play in military operations. The range of missions goes well beyond the missile defense role and space applications described in the previous chapter. They include ultra-precision strike, anti-ship cruise missile defense, battlefield theater support roles such as illumination and designation, information gathering and relay, air-to-air and air-to-ground operations, operations other than war, and many others. The following concepts are discussed:

- Advanced Tactical Laser.
- Ground-Based Laser for Space Control.
- Evolutionary Aerospace Global Laser Engagement System.
- Tactical High Energy Laser Fighter.
- Future Combat System Applications.
- Countermunitions.
- Maritime Self-Defense.
- Large-Aircraft Self-Defense.
- Operations Other Than War.

ADVANCED TACTICAL LASER

The Advanced Tactical Laser (ATL) is an emerging concept for a family of compact, modular, high-energy laser weapon systems. This family of systems would have a high degree of commonality at the subsystem level and draw heavily on technology developed over the last decade in various Army and Air Force programs. The ATL could provide a unique capability to conduct engagements at significant stand-off distances with little or no collateral damage, as shown in Figure 28. Platform independent, the ATL can be designed as a modular weapon system that can roll on and roll off any number of tactical platforms, including ground fighting vehicles, tactical aircraft, or rotorcraft. This modular system concept is illustrated in Figure 29. As proposed, the weapon element of the ATL would be readily reconfigured for ground-vehicle installation.



Figure 28. ATL Concept

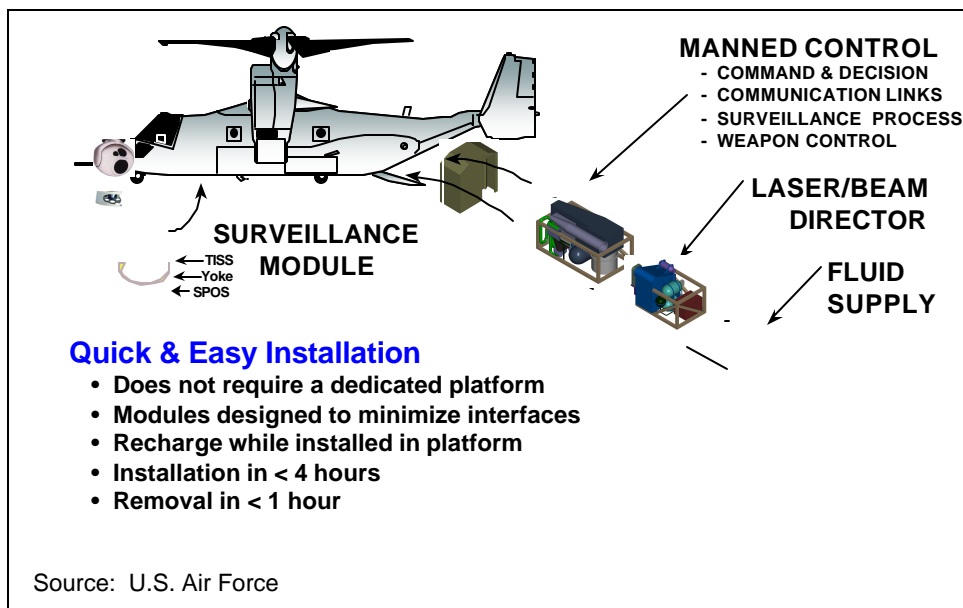

Figure 29. Modular Weapon System

The JROC has approved the ATL to begin in FY 2001 as a four-year ACTD. The four-year program is structured as two years of design and fabrication, one year of system integration, and one year of system tests, as depicted in Figure 30. System testing is planned for the High Energy Laser System Test Facility and the North Oscura Peak facility, both at the White Sands Missile Range. After the four-year period, the ATL residual hardware will be available for extended operational evaluation and use in field exercises. For the Joint Non-Lethal Weapons Directorate, the U.S. Marine Corps, the U.S. Special Operations Command, and the Army

Space and Missile Defense Command and Air Defense Artillery, ATL offers an opportunity to evaluate an integrated laser weapon operating in the field. In particular, it would offer the opportunity to evaluate low-altitude, tactical, air-to-ground operations.

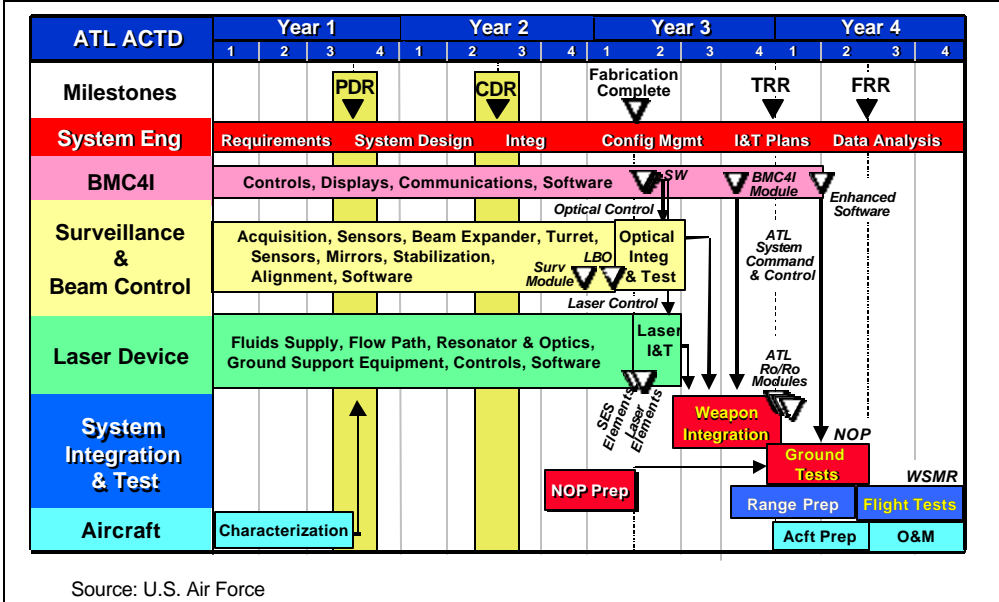

Figure 30. ATL Program Plan

The ACTD schedule is based on the Boeing COIL module using a sealed exhaust, currently operational at the 20 KW level. A fuels recycling system enabling completely closed cycle operations is also under consideration. It is possible that by the time the ACTD concludes, a comparably powered solid-state laser will be far enough along in development for consideration in production variants of the ATL system. Various platforms are also under consideration including the C-130, CH-53, CH-47, and the MV-22.

OPERATIONAL CONCEPT

The ACTD will focus on the "ultra-precision strike" mission area. In these operations military action is required, but rules of engagement are strictly controlled and collateral damage must be limited. The ATL is envisioned to offer the mobility of a small aircraft, high-resolution imagery for target identification, and the ability to localize damage to a small area of less than a foot in diameter. From a standoff distance of a few miles, the ATL would not be subject to direct attack by small arms or shoulder-launched anti-aircraft missiles. In fact, it could be far enough away that its action is almost covert. The laser beam is silent and not

visible even at night. The effect of the beam may not be easily associated with the presence of an aircraft several miles away.

In these situations an ATL is thought to have the capability to disable communications lines, disable radio and TV broadcast antennas, disable satellite or radar dishes, break electrical power lines and transformers, disable individual vehicles, and create various forms of distractions by setting small fires. These actions would serve to isolate and control hostile individuals and groups without casualties and with minimal, repairable damage.

With this emphasis on ultra-precision strike, the ACTD will necessarily place a high emphasis on precise control of the high-energy beam. Propagation of the laser will benefit greatly from the reduced turbulence associated with avoiding the first few hundred meters above the earth's surface, but will suffer from the increased vibration of an aerial platform and the turbulence created by the rotors. The precise targeting will require a flexible fire control system.

Alternative ATL concepts have been explored. With increased power, anti-ship cruise missile defense is one potential mission. In open seas, Navy ships are well protected by their own air cover and missile systems that prevent enemy launchers (ships or planes) from getting too close, but in certain circumstances the risk of attack at relatively close range cannot be avoided. The risk is compounded if the threat includes supersonic cruise missiles whose speed reduces the time available for defensive actions.

SYSTEM CONCEPT

The laser system hardware will be designed and built by Boeing. The laser is a 2.5 X scale-up of an existing laser, and the optical system is scaled down in size and complexity from the system used in the Airborne Laser program. The weapon system will be self-contained, with its own surveillance sensors, a separable control console, and a completely portable ground package to manage the laser fluids processing.

The Boeing approach is to assemble the entire weapon system on four pallets that can be loaded into any available V-22. At this point, Boeing has not identified a need for any substantial modifications to the V-22. A roll-on, roll-off package could also be designed for the CH-47 Chinook helicopter. Airplanes like the C-130 have more than the needed weight and volume capability, but would probably require a structural modification to accommodate the external turret.

At the ATL operating altitudes, the external ambient air pressure is such that the ejector system can't exhaust the laser gases directly against

this pressure. Hence the ATL, using the V-22 and COIL as point design, must use a "sealed exhaust system," which is basically a box full of cold zeolite. Zeolites are a family of commercially available materials that can be used in a wide variety of applications to trap impurities in process flows. In the ATL application, zeolite adsorbs the laser gases in its internal microstructures, to up to 20 percent of its own weight. At liquid nitrogen temperatures, the vapor pressure over the zeolite bed is low enough to pump the laser exhaust. The zeolite is recycled by warming it up to drive off the absorbed gases. It can then be cooled and reused.

Boeing demonstrated this novel approach in an internal development program in conjunction with a variant of the COIL laser. The ATL differs from other COIL devices such as the ABL COIL, because it cannot use helium as the carrier gas for the reactants. Zeolite cannot pump helium, so a helium-free COIL is required for the ATL application. A compact COIL device, using nitrogen as the diluent with a sealed exhaust system that captures all of the laser exhaust gases, was demonstrated by Boeing at 20 KW in March 1999 as a compact sealed COIL laser.

The OSD Joint Technology Office (JTO) has provided funding to initiate work at Air Force Research Laboratory (AFRL), leading to useful characterization of the Boeing 20 KW device. The High-Power Gas and Chemical Lasers Branch at AFRL (AFRL/DELC), with Boeing support, will test the ATL in the Advanced Laser Facility to develop software for operational control and data acquisition. It will then carry out technology enhancement testing to optimize the laser system for operational use.

The ATL ACTD will also address the reprocessing of all of the spent laser fluids, converting them back into the original reactants and diluent ready to be used again. Though a significant duty cycle for overall operations would remain, processing of this type represents a significant step forward in logistic suitability. This innovation, called the EC COIL Fuels Regeneration System, has been shown to be feasible on a laboratory scale, and is planned to be scaled up during the course of the ACTD to be compatible with the demonstrated compact sealed COIL laser.

SYSTEM DEMONSTRATION

The demonstration will be conducted in two phases. First, the complete system will be demonstrated on the ground in a "mountain-top" geometry that mimics the air-to-ground scenario. The Air Force Research Laboratory operates a large optical system beam control test bed at North Oscura Point on the White Sands Missile Range where this test will be performed. The hardware will then be installed on the aircraft for "live-fire" tests against fixed and mobile ground targets, supported by the

Army's High Energy Laser System Test Facility, also at White Sands Missile Range.

TASK FORCE FINDINGS

1. The ATL ACTD provides a potential path to roll-on, roll-off HEL capability on tactical transport and large, helicopter-sized platforms compatible with Air Force, Navy/Marine Corps, and Army platforms. The initial ATL concept requires a sealed exhaust system, which is to be demonstrated as part of the ACTD—a need that is compatible with the EC-COIL Fuel Regeneration System also needed for the HELSTAR set of programs. Potential growth paths to solid-state lasers are included in longer range planning.
2. Successful demonstration of the ATL ACTD also depends on significant advances in precision beam control in a cluttered environment for the lower-altitude, turbulent atmosphere—including the added turbulence generated by the downwash of rotor systems or the boundary layer around aircraft.

GROUND-BASED LASER FOR SPACE CONTROL

Ground-based lasers (GBL) offer options for space control and theater support. In conjunction with a space-based mirror constellation, the applications could include space control, laser communications, and other battlefield support to include illumination and designation.

Ground-based lasers located at high-altitude, but accessible, locations have some inherent advantages relative to space-based lasers:

- Nearly unlimited magazine.
- Ease of maintenance.
- Relatively little limitation due to size and weight.
- Fielded cost to deploy and support.

These lasers also have inherent limitations:

- They must propagate through the atmosphere.
- Weather and atmospheric propagation limitations are significant.

- They require a mirror constellation (larger than that required by the SBL).

SYSTEM CONCEPT

The basic concept for this capability is a large ground-based laser and beam director that can destroy or threaten satellites providing surveillance or strike capability against U.S. ground, air, or space military forces. Because of the effects of weather and atmospheric absorption, ground-based lasers would have to operate at wavelengths less than 1.5 microns and greater than 0.5 microns. Location at sites with minimum cloud cover would also be important to minimize the time when the system would not be effective.

For low earth satellites (with altitudes up to 1000 kilometers), typical ranges would be on the order of 2000 kilometers. Fluence on typical targets on the order of 100 watts per square centimeter over areas of 1.0 square meter would probably be sufficient to effect kills in about 10 seconds.

These parameters lead to the need for a laser with a CW power output of several megawatts to overcome system and atmospheric losses. With a 1.0-micron wavelength, a beam director of about three meters in diameter would be needed. The beam director would have to be equipped with a very capable atmospheric turbulence compensation system that maintained atmospheric turbulence losses to less than 50 percent. The technology needed to produce such a system is considered to be state-of-the-art, although significant engineering challenges exist.

The GBL system could also offer a minimal capability against satellites at synchronous orbit and lower intermediate altitudes. At these much lower fluences, on the order of 0.5 watt per square centimeter, the kill mechanism would likely be thermal overload of the satellite body or its solar arrays. Illumination for 100 seconds or more would probably be required.

It should also be noted that the airborne laser currently under development, or its successor, would also have a significant capability against lower orbit satellites.

OPERATIONAL CONCEPT

Employing a GBL capability would involve locating one or more system(s) in the United States at a fixed site(s). Multiple sites will be required if high availability is needed due to periodic weather outages. The

site would be highly secured against heavily armed infiltration, aircraft, and cruise missile threats. The system would need chemical storage vessels and its own source of electrical power. A target list and data on satellite location would be maintained on site. Most (if not all) ISR satellites of military interest are polar orbiters, and therefore will come over a fixed location in the continental United States (CONUS), normally twice a day. The system would be limited to attacks against targets in low earth orbit until relay mirrors are available. With relay mirrors, access to much higher altitudes will be possible.

CONCEPT DESCRIPTION

The GBL system uses at least three lasers, two telescopes, and potentially a radar. One laser illuminates the target. A 3.5-meter telescope detects the illumination. A sodium (Na) laser is used to determine the atmospheric conditions on the path to the target. The Na laser beam is projected into the atmosphere ahead of the target from the 3.5-meter telescope; the telescope also receives the return from this illumination. The third laser, the COIL, is used to destroy the target. It also is projected out of the 3.5-meter telescope. A 1.5-meter telescope senses the reflected return off the target from the COIL destruct laser. This telescope also detects the location of the infrared hot spot of the target. The GBL system makes adjustments to ensure the destruct laser is constantly aimed at the hot spot.

Satellite Tracking

The GBL would optically track the satellite target. Passive satellite acquisition would be achieved by sensing the satellite's IR signature after a hand-off from either a nearby radar system or from the Spacetrack catalog ephemeris data. Passive acquisition would be supplemented with visible light sensors that could be used when the satellite is illuminated by the sun. After the satellite is detected, it would be handed off to an active tracking system. An illumination laser would flood illuminate the target satellite. The baseline illuminator laser is a pulsed diode-pumped Nd:YAG laser at 1.06 μm . The return from this illumination would enter the 3.5-meter telescope and be focused on a focal plane array.

The focal plane array would operate in the near-IR spectrum to detect the illumination laser return signal. The output signal from the focal plane array would close a high-bandwidth track loop. Thus the apparent position of the target would be constantly known. The return from the illumination laser could also be used as an input to an adaptive optics system that would carefully focus the illumination spot on the target. If adaptive optics are not used, a 10 KW illumination laser would be required. With adaptive

optics a few KW would be required. Because the speed of light is not infinite (186,200+ miles per second) the target's real position is ahead of the apparent position along the orbital flight path. Thus the destruct laser must be aimed ahead of the target in order to hit it.

Atmospheric Compensation

The atmospheric compensation system consists of an adaptive optics system and an artificial beacon sensing system.

The density of the atmosphere is uneven. As light travels through these changes in density, it is refracted in different directions. Anyone who has seen stars apparently flicker in the night sky has seen this effect. In order to deposit as much of the destruct laser energy on the target as possible, the focus of this laser must be continuously adjusted to compensate for atmospheric distortions. Unfortunately the distortion information from the apparent object cannot be used to determine needed compensation because it does not travel the same path the destruct laser energy will take to the target. Instead, the distortion characteristics of the path ahead of the target must be determined. This is a difficult task, as most likely there will be nothing in this path from which to gather reflected light.

The approach to this problem is to take advantage of an unusual characteristic of the outermost reaches of the atmosphere. This area (95 km altitude) contains minute concentrations of sodium atoms deposited via meteor collisions with the upper atmosphere. The GBL system concept would use a laser operating at a frequency that stimulates sodium atoms. The sodium wavelength beacon laser would need an average power of about 200 W and a rep rate of 1 kHz. This laser would be aimed at the expected target intercept point in space. Sodium, even in minute concentrations, responds strongly to the laser stimulation and emits all of its light energy at a very specific frequency (in the yellow light band). This returning light contains information about the distortions in the atmosphere through which it has passed. Sodium lasers require more development in order to achieve 200 W output.

This distorted light returns to the GBL and enters the adaptive optics component of the GBL contained in a 3.5-meter telescope. This section consists of a wavefront sensor, reconstruction, control interface, and a deformable mirror. The wavefront sensor detects the atmospheric distortions. This information is used to generate signals that constantly adjust up to 900 servos connected to the deformable mirror. The servos movement deforms the mirror. The destructive COIL light enters the adaptive optics section of the 3.5-meter telescope and is reflected by this special deformable mirror. The hundreds of servos can adjust the surface of this mirror in milliseconds. The destructive laser beam is counter-distorted by the mirror in such a way as to cancel out the distortion in the

atmospheric path to the target. The mirror constantly adjusts as new distortion information is fed into the system. By this manner a narrow, focused beam of destructive laser energy is deposited on the target. Deformable mirrors using 941 servos have been built and tested.

The beam train optics (including the 3.5-meter mirror) are generally a low coefficient of thermal expansion substrates. Cooling requirements are being determined. High reflectivity coatings for uncooled optics are being produced. A cooled adaptive mirror has been constructed and tested and will be used in the event that the uncooled optics fail to perform adequately. Work continues to improve the coatings, anti-light scattering, high reliability and durability properties. Concepts for monitoring the condition of the optics between firings are being developed.

The 1.5-meter telescope would sense the destructive laser's current target hit spot (it would sense the heat on the target in the IR spectrum), and it would sense the hottest spot on the target (caused by previous COIL illumination). Should the destruct laser hit spot wander from the hottest spot, the destruct laser would be repointed to the hot spot. Damage on the satellite would be sensed via the 1.5-meter telescope.

An alternative to the 200 W sodium laser is a fourth laser to be projected from and received by the 3.5-meter telescope. It would sense lower-altitude atmospheric Rayleigh scattering. This data would be combined with the data from the lower-powered Na laser to provide atmospheric compensation information.

Generating a Destructive Laser Beam

The COIL is the most likely candidate for a destructive laser in the GBL system. Much of the technology required for the COIL has been developed for the Airborne Laser. For this application, the COIL must produce megawatt-class power levels with good beam quality and run times of up to 100 seconds. Experimental devices have demonstrated multi-hundred KW for extended run durations. The proposed concept involves four independent COIL gain generators coupled together to form a single resonator that extracts the required power. This coupled resonator concept has been demonstrated. Technology to cool the gain generators is well within current technology levels. Performance prediction codes have been validated by several COIL experiments. Overall, there is significant synergism with developments in the ABL program.

COIL technology development focuses both on improved system efficiency and on cost and weight reduction. It has not been decided which type of excited oxygen generator will be used. Spray technology or rotating disk technology are both being considered. Experiments have been performed with deuterium-based fluids in place of hydrogen-based

fluids in order to improve output power. The iodine mixing nozzles are also being improved.

It does not appear that thermal blooming (the distortion caused by atmospheric absorption of laser energy) will significantly affect the design of the COIL at the power levels required. This issue is still under exploration for missions involving relay mirrors and higher power levels.

Costs for a single GBL site were estimated several years ago at approximately \$2 billion. More recent work in COIL for ABL has reduced the risk of technology development.

FREE-ELECTRON LASER OPTION

A free electron laser (FEL) may be an appropriate candidate for GBL applications. The FEL's main disadvantage—its large size—is relatively unimportant for GBL systems. But its advantages—potential scalability to very high powers and ability to support very long run times—can be extremely valuable in ground applications. These advantages motivated the Strategic Defensive Initiative Office (SDIO) to select the FEL as the candidate laser for a potential GBL ballistic missile defense system. Although no higher-power FEL was ever built under the SDIO program, considerable work was done to verify the advantages of an FEL for this mission.

Careful absorption measurements identified an atmospheric absorption minimum near 1 μm . By tuning the FEL to this precise wavelength, thermal blooming can be minimized. A combination of SDIO-funded experiments and calculations demonstrated that, at the optimum FEL wavelength, thermal blooming could be compensated for at power levels appropriate for the BMD mission.

BEAM CONTROL DEMONSTRATION PROJECT

The key enabling technology for practical laser weapons is beam control—the combined use of pointing, tracking, and atmospheric compensation to efficiently propagate laser energy through the atmosphere and deposit it on a target. While significant advances in laser beam control technology have been demonstrated at the Starfire Optical Range (SOR) in Kirtland Air Force Base, New Mexico, the ability to propagate a compensated laser to a satellite target from a weapons-class (3.5-meter) aperture has not been demonstrated.

The Air Force beam control demonstration project will use the SOR 3.5-meter telescope, a 941-channel adaptive optics system, and a low-

power laser to illuminate a satellite target and quantify the effects of atmospheric compensation and tracking performance. In FY 2003, this project is to conclude in an integrated beam control demonstration, combining point-ahead compensated laser projection, compensated imaging, active tracking, and measurement of laser energy on a satellite target in low earth orbit.

The demonstration will be based on laser weapon beam control technologies currently being developed under the Air Force Ground-Based Laser Technology Program (Defense Technology Objective WE.10 Integrated Beam Control for Ground-Based Laser Anti-satellite System). The proposed work involves the development of a target-loop atmospheric compensation capability on the SOR 3.5-meter telescope and propagation of a low-power target-loop compensated laser to a low earth orbit satellite target. Measurement of the peak intensity and beam profile on the satellite will be made by scanning the beam over the satellite retro-reflector and collecting the time series return signal at the SOR 1.0-meter coelostat.

The primary metrics are atmospheric compensation performance, residual satellite tracking error, and laser beam pointing accuracy for aimpoint stabilization. This experiment will be the first to propagate a compensated laser beam from a GBL weapons-class aperture to a satellite, and will be the first to measure beam control system performance from an appropriately sized system. The experiment will also characterize anisoplanatic effects due to the laser beam traveling a different path than the turbulence measurement used by the adaptive optics. Preparation for this experiment will also include experiments in target-loop high-resolution compensated imaging of satellites and high-fidelity measurements of pointing, tracking, and aimpoint maintenance errors against candidate target satellites.

This work will be done in parallel with active tracking and satellite imaging experiments done under the AF GBL program in FY 2001. Results will be incorporated in FY 2002 and 2003 GBL work, which will combine the target-loop compensation capability developed in FY 2001 with active tracking and laser beacon adaptive optics. A series of increasingly complex integrated beam control field tests will culminate in a final FY 2003 integrated demonstration, at full scale but very low power, of all beam control functions associated with an end-to-end satellite engagement.

The major functions of this integrated beam control demonstration include initial optical acquisition of the target satellite, flood illumination of the satellite with a low-power laser, handoff to precision active tracking, point-ahead atmospheric compensation using adaptive optics and Rayleigh laser beacon sensing, designation of the desired aim point on the satellite target, compensated laser beam propagation to the selected aim point, and aim point maintenance for the required engagement time.

This program will develop and demonstrate the necessary beam control capabilities required for effective ground-based laser antisatellite weapons. Further integration with HELs and engineering for high-power operation would be required to achieve an operational system capability.

S&T NEEDS

The Air Force demonstration project, described in Figure 31 below, is developing the technologies that would enable a fixed GBL system for use in anti-satellite applications against adversary satellites in low earth orbit and in degrade and destroy operations against adversary satellites in medium-earth orbit and geo-synchronous orbit. Specific needs include:

- Adaptive optics for large mirrors.
- Scaled COIL technology.
- High-power optical components.
- Active satellite tracking.

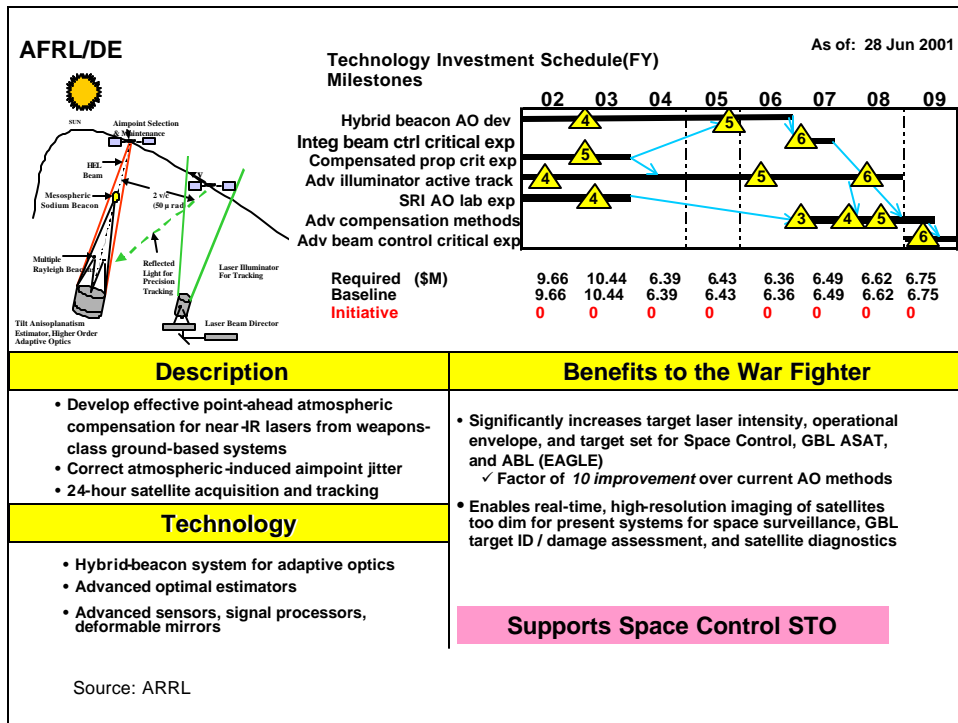

Figure 31. Advanced Ground-Based Laser Beam Control for Space Control Operations

TASK FORCE FINDINGS

1. A continuous wave (CW) system with a power output of several megawatts, having the potential to be highly effective against low-orbit satellites, and with some effectiveness against synchronous orbit satellites, is within the state-of-the-art. Much of the technology and required levels of performance have been demonstrated or are under current experiment, but there is still some significant S&T work that must be accomplished.

EVOLUTIONARY AEROSPACE GLOBAL LASER ENGAGEMENT SYSTEM

The Airborne Laser will be a flexible and effective weapon system, but global coverage of missile launch sites will be difficult to achieve. Sites of interest must be selected in advance of deployment, and missions must be planned and executed hours, or perhaps days, in advance. Overflight restrictions may limit, or in some cases eliminate, the utility of the system.

With the necessary resources and effort, it is possible to deploy a space-based laser system to provide global coverage of the world's missile launch sites on a 24-hour basis. Although the cost will be tens of billions of dollars and development and deployment times will be decades, the United States may want to commit to such a system.

Both of these systems are designed to destroy missiles in their boost phase. Only by doing so can warheads be destroyed without having to contend with decoys and other countermeasures. Instantaneous and continuous global coverage demands a space-based system, but an architecture for such a system can include lasers deployed in space, lasers deployed on the ground that interact with space-based relay mirrors to provide world-wide coverage, or a combination of the two. Independent of the architecture, development of both ground- and space-based lasers for missile defense should continue.

Concurrent with these developments should be the development of relay mirrors—and their pointing and tracking systems—that can be used with both ground- and space-based lasers. There are many applications for relay mirrors using lasers with power far below that required for lethality against missiles and other targets. Many studies have identified these applications and recommended that high- and low-power relay

mirrors be a significant part of the Department's space vehicle and directed energy programs.

RELATED STUDIES

Several related studies contributed to the development of the *Air Force Directed Energy Master Plan*. The *Global Energy Projection Study*, led by the Air Force Chief Scientist, provided recommendations for the appropriate mix of space-, air-, and ground-based laser systems for Air Force missions in global energy projection. This study, briefed in August 1999, concluded that:

- A layered defense with mutually supportive fire is the optimal architecture for ballistic missile defense.
- A space element is required for national missile defense.
- SBL could alter adversary military strategies and create stability, especially in peer competition environments.
- SBL will most likely employ a chemical laser if deployed within 20 years.
- The value of space relay mirrors needs to be examined in greater detail.
- Electric lasers show promising possibilities in the future, but there is no investment in high-power sources for electricity for space applications.
- The industrial base for directed energy and supporting directed energy elements is thin.

AFRL also conducted the *Lasers and Space Optical Systems (LASSOS)* study, under the guidance of General (retired) Piotrowski. LASSOS identified several missions where laser systems could make a contribution. These missions include the areas of information gathering, information relaying, and support to military operations through guidance, illumination, and instrumentation. From a robust list of possibilities, the study identified eight areas for investment focus:

- Chemical warfare agent detection and identification.
- Theater wind profiling.
- Tunnel and underground structure detection.
- Camouflage detection and penetration.
- Lasercom to airborne command post.

- Imaging from geo-synchronous orbit.
- Laser fence for low visibility aircraft detection.
- Illuminator for nighttime and active imaging.

The study also noted the potential non-weapons application of HELs for power relay, space debris clearing, and laser propulsion. Figure 32 shows the advantage of relay mirrors as recommended in the study for low-power laser missions.

In 1999, Space and Missile Center and BMDO conducted the *Space High Energy Laser Architecture and Affordability Study*. The objective of this study was to define the most promising HEL concepts, in the 2020 time frame, for performing boost-phase ballistic missile defense and ancillary missions, and to identify the technology development path to enable these concepts. The study concluded that architectures with space-based lasers and relay mirrors may provide the best opportunity to accomplish these missions at affordable costs, but are considered high risk because of the technology advances required in the next fifteen years to make them practical. The potential benefit of using relay mirrors for these types of missions is shown in Figure 33.

- Advantages of relay mirrors
 - More capability since lasers need not be space qualified
 - More laser capability (wavelengths and pulse formats) and flexibility possible
 - Terrestrially-based lasers can be easily maintained
 - No run-time limits for lasers that require consumables
 - The RM is a cooperative target for atmospheric compensation
 - Significant increase in ISR capability

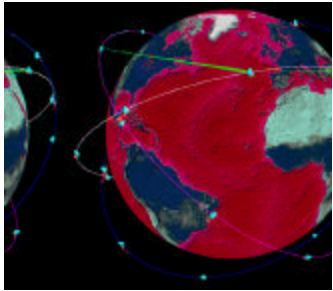

- Global infrastructure for
 - Global information
 - Global force enhancement
 - Global force projection

Source: AFRL

Figure 32. LASSOS Relay Mirror Observations

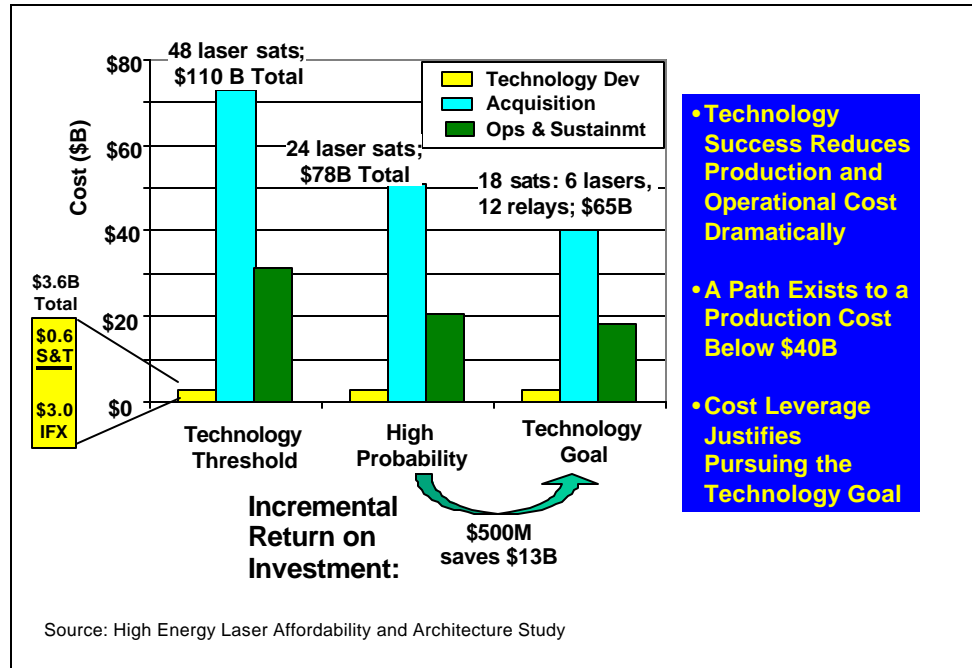

Figure 33. Rationale for Relay Mirror Technology Investment

EAGLE PROJECT SUMMARY

Relay mirrors have been proposed as a major operational and affordability enhancement for a wide range of future HEL and low-power laser applications.⁵ The Evolutionary Aerospace Global Laser Engagement (EAGLE) System is the culminating result of these many proposals. The EAGLE system utilizes relay mirrors with a variety of laser sources to perform multiple laser missions, as shown in Figure 34.

The EAGLE concept allows for the relay mirror satellites to support multiple missions, depending on the operational concepts and the laser sources that support them. Terrestrial and space-based low-energy lasers could support all of the LASSOS missions. Ground-based HELs, the Airborne Laser, and Space Based Laser would support lethal missions. Prior to the availability of space-based lasers, ground and air laser sources could be used to perform many lethal missions such as theater missile defense, ground and air attack, and counter-space, as shown in Figures 35 and 36.

⁵ Discussion of these applications can be found in the following references: *The Space High Energy Laser Architecture and Affordability Study*, the *Lasers and Space Optical Systems Study*, the *Air Force Directed Energy Master Plan*, and the *OSD High Energy Laser Master Plan*.

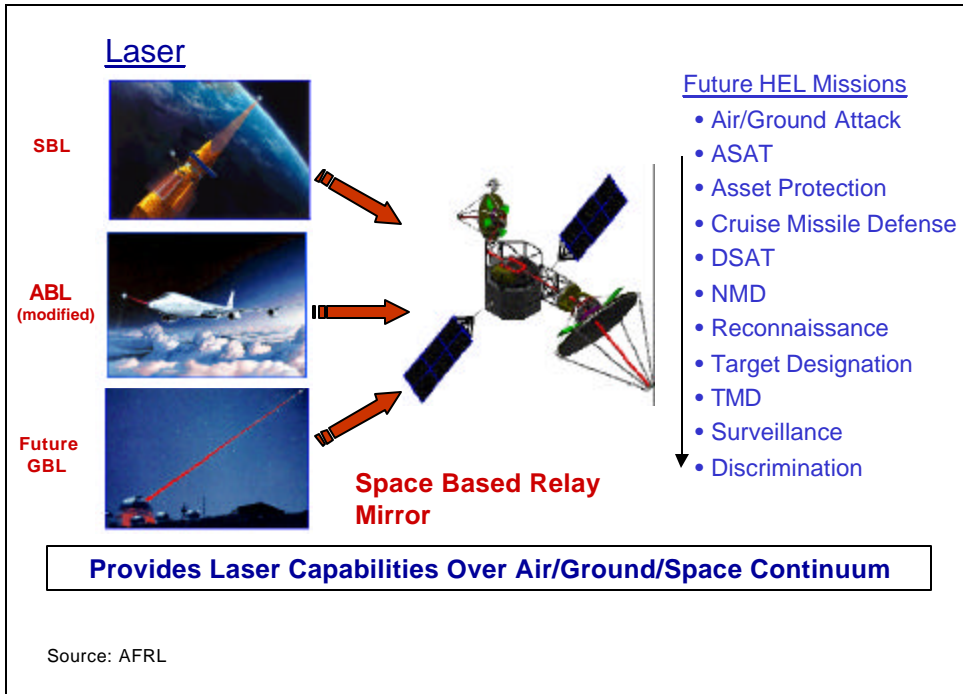

Figure 34. Eagle Concept

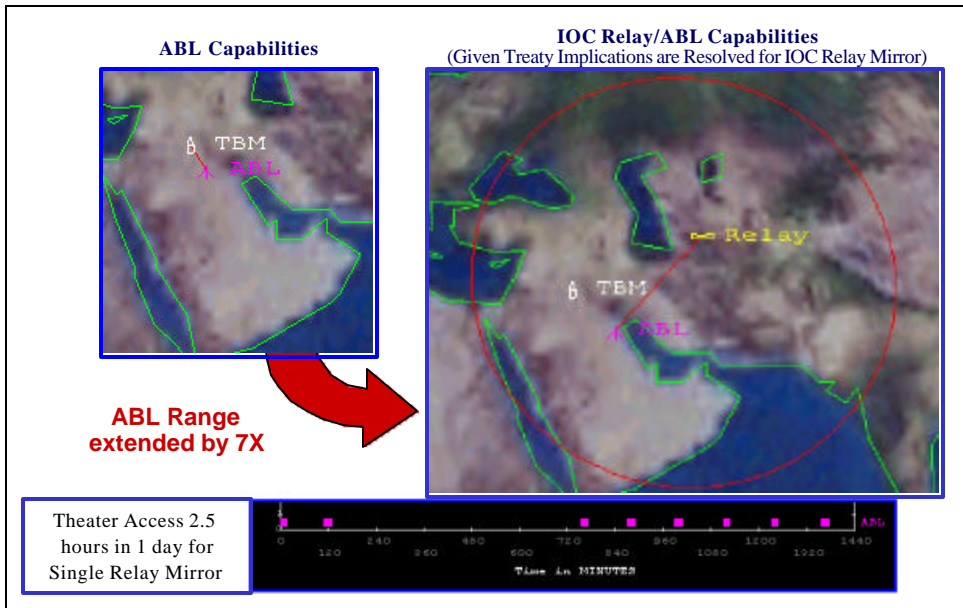

Figure 35. Single Relay Mirror Opportunities to Perform Ancillary Missions

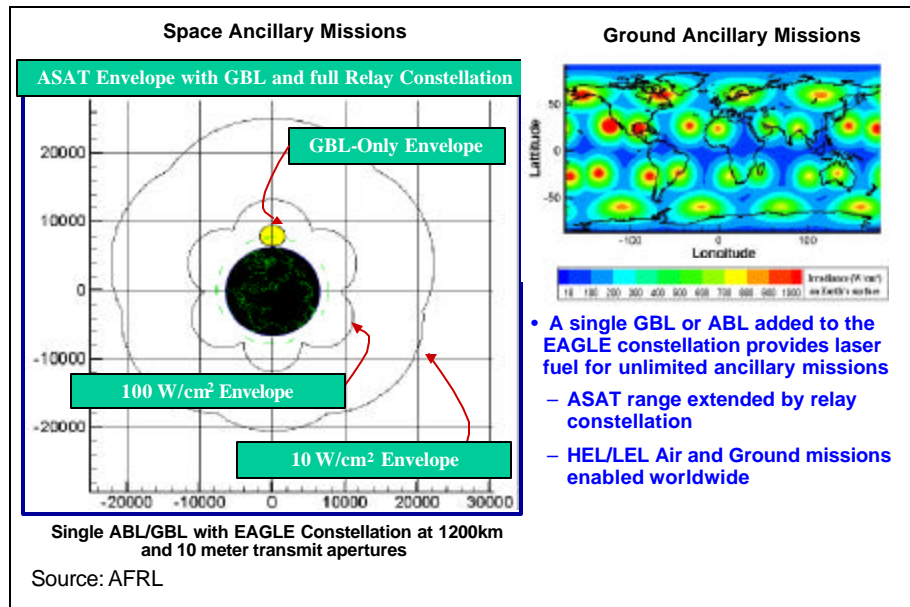

Figure 36. GBL and ABL Provide EAGLE with Unlimited Ancillary Mission Capability

While some preliminary studies have been carried out, a more comprehensive analysis and system design needs to be developed—one that incorporates all key subsystems in a relay mirror system, identified in Figure 37. This analysis needs to be linked to technology development in a number of areas—beam control and dual line-of-sight as well as satellite attitude control and momentum management—to meet the needs of a relay mirror application.

Relay mirrors present unique challenges in beam control and dual line-of-sight because of the need to collect laser light from ground-, airborne-, or space-based platforms and relay it through a different optical system, at a different location. Meeting this set of needs requires specific beam control solutions. Furthermore, the two independent optical systems have to point and track towards different locations. This implies a hierarchy of structural and optical control never before demonstrated, as illustrated in Figure 38.

Relay mirror satellite concepts also pose unique problems for satellite attitude control and momentum management. Satellite systems normally fall into one of two categories. In one case, systems with large, one-time deployment structures are locked into place, once deployed, and thereafter behave as a single rigid body. Alternatively, satellite systems with small deployable members are reoriented during satellite operations. In either case, the satellite system lends itself to attitude control and momentum management via traditional approaches. In the first case, control is generally not an issue during deployment, and the satellite system behaves as a unit post-deployment. In the second case, the forces generated by the

slewing of the smaller unit can be treated as a perturbation force on the pointing controls of the main satellite, and thus can also be rejected via standard techniques.

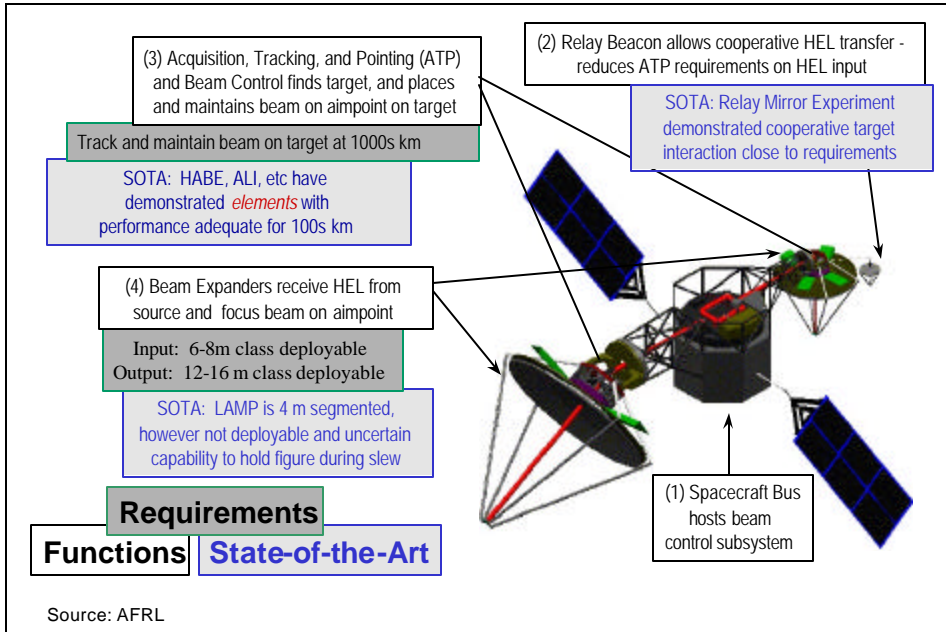

Figure 37. Key Relay Mirror Subsystems

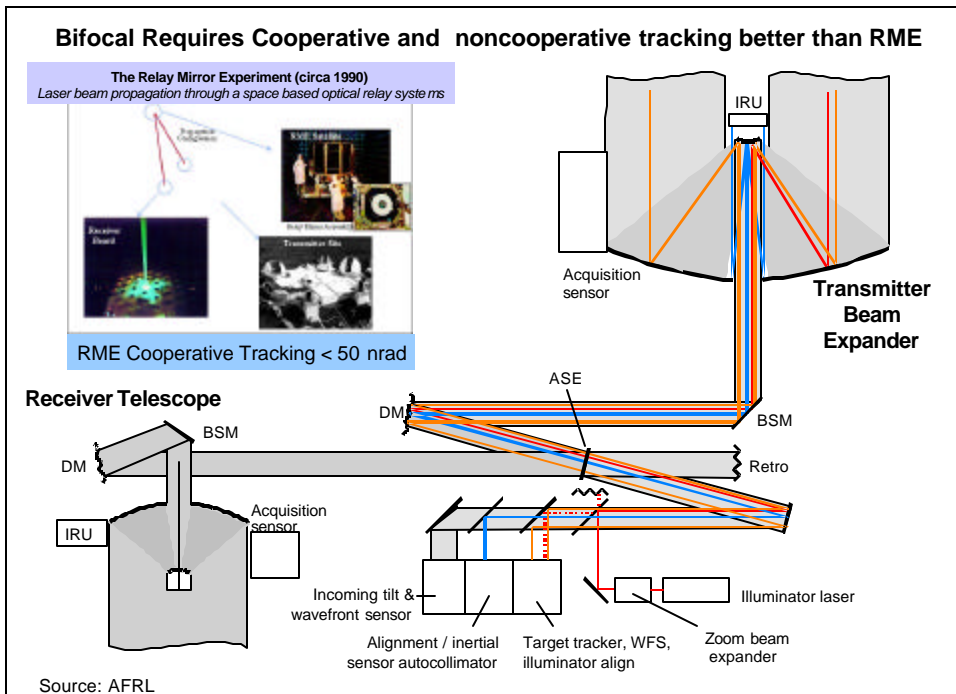

Figure 38. Relay Mirror ATP Concept

OBJECTIVES

The objective of the EAGLE project is to initiate the development and validation of key technologies to enable a future, affordable integrated HEL capability based on a relay mirror architecture. In this framework, an alliance between AFRL, industry, and academia is being established. Relevant key technologies have been prioritized based on several years of research and development experience at the AFRL, coupled with results from recently completed and ongoing architecture studies that evaluated both the military utility and technology needs for future relay-mirror-based systems. Based on these priorities, the project will focus on two areas: novel beam control and steering technologies and dual-line-of-sight control.

Novel Beam Control and Steering Technologies

Study in this area will address how specific concepts affect beam control. For example, the use of a single bus satellite with two independently gimballed optical systems will allow for a relatively simple beam control mechanism as compared to a system where the telescopes are rotating independently along a common optical axis joining them together. In the point-and-tracking arena many issues involve the use of nonmechanical beam steering in order to decrease complexity, weight, power consumption, and, ultimately, cost. Several electro-optical systems have been demonstrated based on either liquid crystal spatial light modulators or micro-machined mirrors. However, these technologies are far from mature, have not been demonstrated in space, or tested with high-energy lasers.

So far, only one experiment at LLNL has been carried out using liquid crystal spatial light modulators for beam correction of a high-power laser. Furthermore, the interplay between beam control and structure control is an important topic of study that has not yet had a satisfactory analysis and testbed demonstration. The beam control system needs to address issues related to variability of the focus of the system and changes in beam expansion train in order to optimize filling the transmitter in a dynamical fashion.

Dual-Line-of-Sight Control

Having two independent point-and-tracking optical systems on a single satellite bus presents formidable dynamic control issues. The ability to control the attitude of the satellite while performing complex, differential, point-and-tracking operations is far from being demonstrated. While some solid background work has been established through studies and preliminary experiments, many crucial aspects of this key technology need to be addressed. Developing a testbed to study and test the mechanical

aspects of the problem would be valuable. The testbed will be used in the out years to integrate the optical side into a more comprehensive testbed. Ground-based telescopes can also be used to verify some of the simulation models that will be produced under this topical area.

The EAGLE project is intended to be one key element of a broad based Air Force technology thrust aimed at eventual realization of a space-based relay mirror demonstration program. In this light, the Air Force will pursue study of a simplified flight demonstration of the dual-line-of-sight control issue. The simplified flight demonstration will be shaped and defined by the proposed studies and testbed demonstration. The technologies that cannot be demonstrated on ground-based platforms will be assessed by either a high-altitude balloon experiment or a space-based experiment. Figure 39 shows the proposed relay mirror technology roadmap.

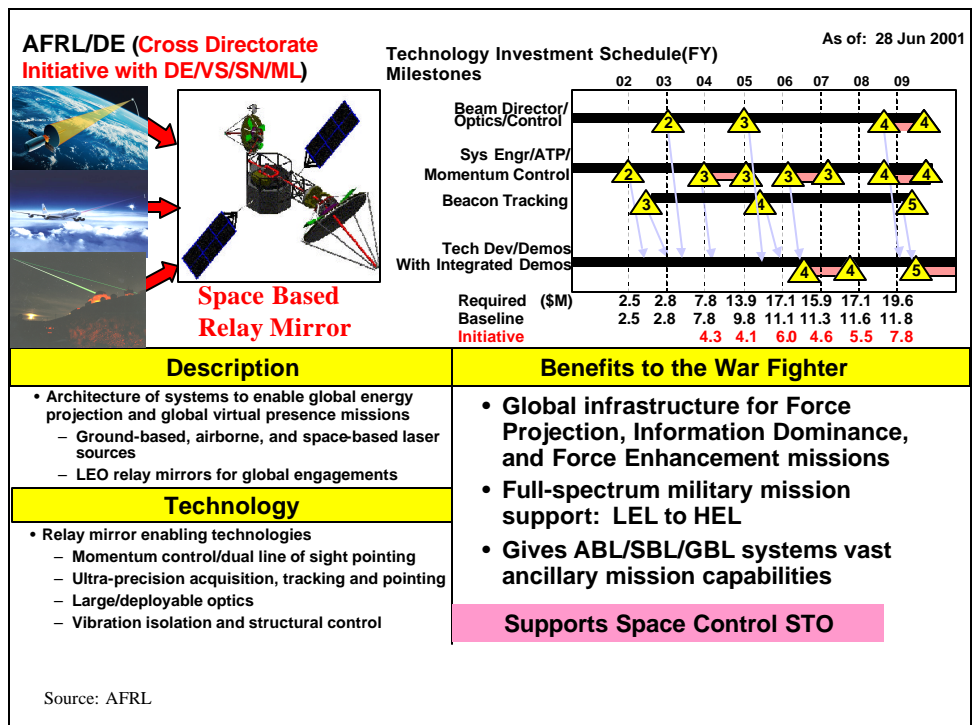

Figure 39. EAGLE Technology Roadmap

TASK FORCE FINDINGS

1. Space-based mirrors that relay high-energy laser beams may offer a significant future enhancement to high- and-low-energy applications.

2. Ground-, sea-, air-, and space-based lasers can feed the SBMs to carry out applications such as ballistic missile defense, space control, and force application against ground, sea, and air targets. In addition, SBMs potentially offer significant stand-alone C⁴ISR capabilities. However, SBMs alone may not provide a viable missile defense, so ensuring that the laser sources work should still be central to the DoD mission.
3. Relay mirrors may offer a more cost-effective way to carry out multiple missions than single, non-space-based systems operating alone.
4. S&T and integrated demonstrations are needed to demonstrate acquisition, pointing and tracking, dual-line-of-sight momentum control, and high-efficiency throughput at the relay mirror.
5. For longer-range applications, such as ballistic missile defense, deployable optics may be required for enhanced capability systems.

TACTICAL HIGH ENERGY LASER FIGHTER

The Airborne Laser program is an example of how far directed energy technology has come. This near-term strategic system is the first step toward the transition of HEL weapons to the warfighter. The next step is to provide the warfighter with a tactical HEL capability.

In a tactical environment, HEL systems can provide many unique mission capabilities including:

- Off-boresight engagements.
- Unlimited magazine.
- Long standoff range.
- Precision engagement
- Negation of anti-aircraft artillery (AAA) threats.
- Plausible denial.
- Mitigation of weather effects.
- Speed-of-light engagements.
- Enhanced aircraft survivability.
- Aircraft self-defense against RF/IR seeking missiles.
- “Re-capture” of the battlefield to 15,000 feet.
- Laser-guided munitions.
- Multi-functional operations.
- Minimum collateral damage.

CONCEPT OF OPERATIONS

A fighter aircraft equipped with a high-energy laser could provide speed-of-light engagement for missions involving air-to-air combat, cruise missile defense, suppression of enemy air defenses, air-to-air and air-to-surface sensing, non-cooperative identification, and attack effects assessment. More importantly, it would provide a paradigm shift in the tactical warfighter's operations.

Several recent breakthroughs have opened the opportunity for high-energy lasers in the airborne tactical environment, as highlighted in Figure 40. First, the potential for significantly increased electrical power onboard tactical aircraft, being achieved under the More Electric Aircraft program, is very important, with a projected capability of 1 MW of power in less than 5 years. In addition, developments in solid-state laser technology, chemical lasers with electro-regeneration of chemicals, fiber lasers, RF waveguide (diffusion-controlled gas electric discharge lasers), and the heat capacity solid-state laser all provide the potential for improved packaging in much smaller volumes suitable for application in a tactical aircraft. The 2000 Offense Only Fighter shows a 10-time reduction in weight in comparison to the 1970s model. Such weight reduction results suggest that an HEL on a tactical platform can become a valuable asset for the warfighter of the 21st century.

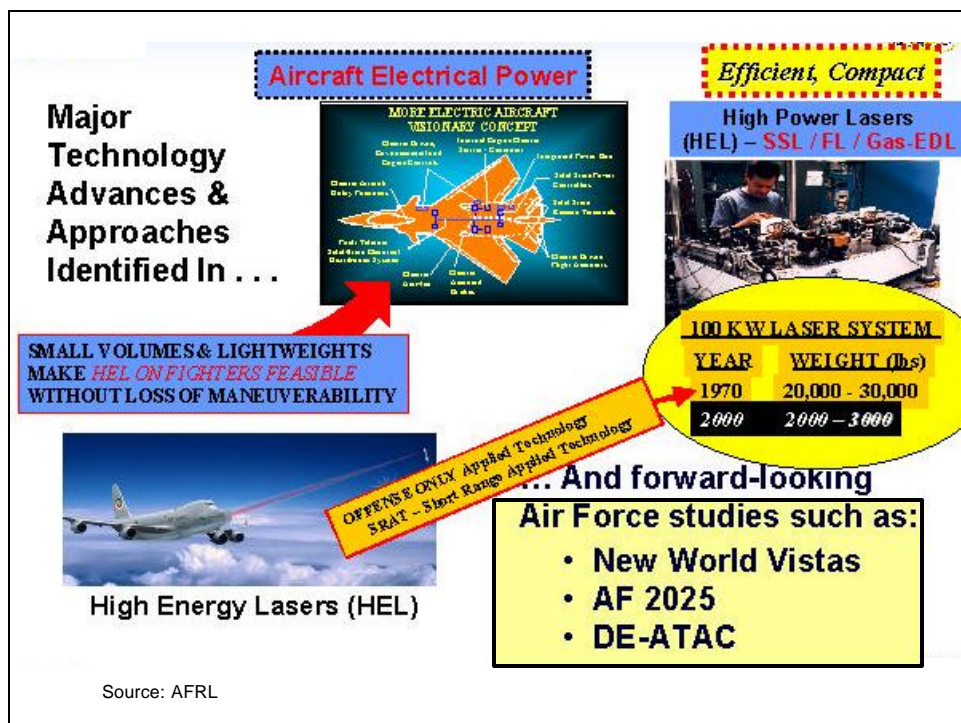

Figure 40. HEL Weapons in a Tactical Environment

Air Force studies have identified potential missions in which HEL systems could significantly change the airborne tactical environment, including air-to-air, air-to-ground, and possibly air-to-space. Figure 41 shows the various missions identified. Figure 42 shows how these missions can be depicted relative to the forward support coordination line (FSCL) for tactical engagements.

“PHASED” IMPLEMENTATION

In reality, there are multiple applications for lasers in the tactical environment. Applications at lower-power levels could include advanced sensing of targets and chemical agents, protection against air- or surface-launched missiles, surface-based electro-optical sensors, aircraft tactical and bomber defenses, and cruise missile defense. In the future, power will be increased and it will be possible to attack ground-based objects. Figure 43 shows a “phased” approach for implementing an HEL on a tactical platform. The rationale is to first use existing lower-power lasers (1 to 10 KW) for possible POD demonstrations and then increase to powers greater than 100 KW to deliver lethal damage.

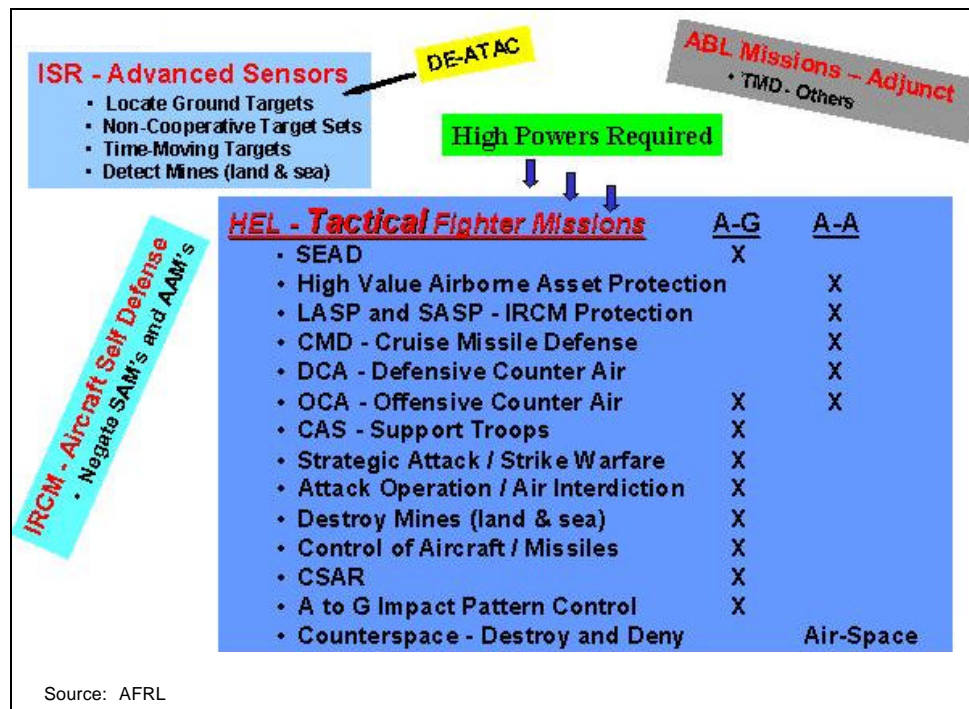

Figure 41. Tactical Missions for HEL Fighter

	Air-to-ground	Air-to-air
Friendly side of FSC	Military CAS CAS – Support Troops SEAD CSAR <i>ISR Capability</i>	DCA (WVR) CMD High Value Asset Protect Protect <i>Self Protect Capability</i>
Enemy side of FSC	OCA Strategic Attack / Strike Warfare Attack Operation / Air Interdiction SEAD CSAR	DCA (BVR) OCA TBMD (ABL Adjunct)

Figure 42. Forward Support Coordination Line with Various Tactical HEL Fighter Missions

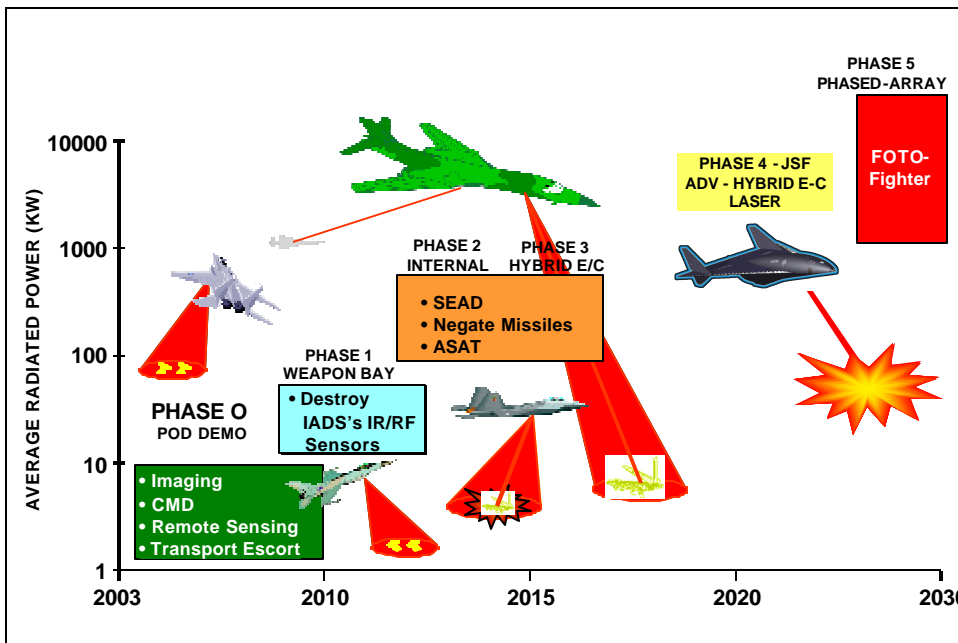

Figure 43. Phased Implementation

CRITICAL TECHNOLOGIES

The key elements of a potential HEL system onboard a tactical fighter platform are shown in Figure 44 below. Critical technologies are needed for the high-energy laser and the beam control system, propagation through the atmosphere, and impinging the target. These combined

capabilities create a desired effect on a specific target: lethal, non-lethal, or intelligence, surveillance, and reconnaissance. Within the tactical platform, the laser and beam control system must compensate for any vibrations and for high g-forces. The beam control system must also account for both the near-field turbulence induced within the free-stream distance around the aircraft *and* the turbulence beyond the free-stream distance to the target. As a result, the beam control system must be extremely dynamic to account for these fast transient processes occurring at kHz rates.

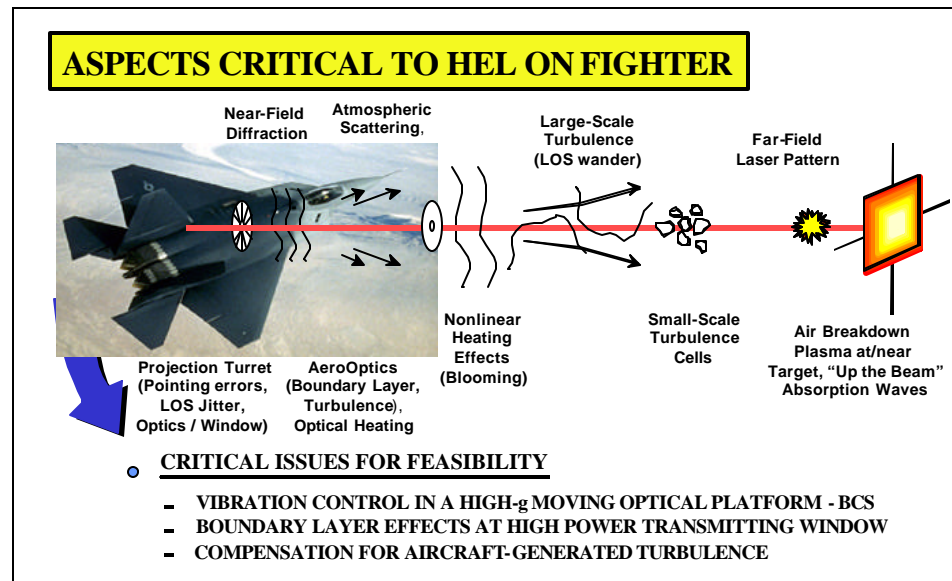

Figure 44. Critical Technologies for Tactical HEL Fighter

Enabling technologies critical for development *and* integration of a high-energy laser and beam control system on an aircraft include:

- Tactically sized 1 to 100 KW HEL with minimum logistics "trail".
- Efficient, small, compact, light weight, and robust system.
- High brightness ($\lambda \approx 1\text{-}2 \mu\text{m}$) for lethal and non-lethal missions.
- 1 KW for enhanced ISR giving long ranges, beyond visual range (BVR).
- Dynamic, advanced beam control system compatible with fighter environment.
- Vibrationally and high compensated—g-factor *insensitive*.
- Employ conformal optics to enhance "effective" aperture.
- Low radar cross section (RCS) *and* infrared counter-measures (IRCM) essential for future fighters, such as the F-22 and Joint Strike Fighter.

Other critical technologies include:

- Aero-optics turbulence compensation for near-field, non-free stream.
- Detailed pulsed and CW effects data for Tactical HEL Fighter “target-sets.”
- “Integrated” HEL-beam control system.
- Advanced weather predictive technique.
- Active heads-up display (HUD) of clouds for specific GPS locations.

SIMULATION AND INTEGRATED DEMONSTRATIONS

To acquire a realistic understanding of the military utility of HEL on tactical platforms, extensive cockpit simulation studies should be conducted. Presently, AFRL-DE is initiating such studies at the Theater Aerospace Command and Control Simulation Facility on Kirtland Air Force Base, New Mexico. The VA directorate of AFRL, along with several aerospace contractors, is conducting similar studies. The value of these studies is immeasurable to the future pilots of tactical HEL fighters.

Future demonstrations of high-energy lasers on tactical platforms are important to their acceptance by the major commands and to advancing the enabling technology to Technology Readiness Level (TRL) 6, a pre-EMD state. A number of demonstrations would be valuable: demonstrating good beam control system operation and long-range sensing with a 1 KW laser in a POD, or demonstrating target recognition with clutter. Scaling the HEL technology toward 100 KW and achieving small weights and volume are absolutely critical to integrating HEL systems on tactical platforms.

AFRL TACTICAL HEL FIGHTER STUDY

The Air Force Research Laboratory sponsored a Directed Energy Applications for Tactical Airborne Combat (DE-ATAC) Study in 1998-1999.⁶ The study reviewed the possible uses of directed energy on tactical airborne platforms in combat. The study identified and prioritized high-payoff airborne tactical applications of directed energy technologies and formulated investment strategies for the Air Force in the key areas of directed energy technologies. In particular, the study closely examined the

⁶ Appendix D contains a detailed summary of the DE-ATAC Study, with particular emphasis on the examination of weather and impact of environmental atmospheric conditions in the tactical battlefield environment.

question of how weather and environmental atmospheric conditions affect the use of HELs for tactical missions and found that with careful mission planning, weather is not a unique deterrent.

The study concluded that a Tactical HEL Fighter is *feasible* and *possible* within 10-12 years provided adequate funding is available, as the schedule in Figure 45 illustrates. A tactical HEL system would add great value to the warfighter in prosecuting military missions across the broad spectrum of possible conflicts. A tactical HEL system added to the weapon suites of current and near-term fighter aircraft would greatly enhance the multi-mission capability of those aircraft, *especially* in the areas of positive target identification, non-cooperative target recognition, and warfare effects confirmation.

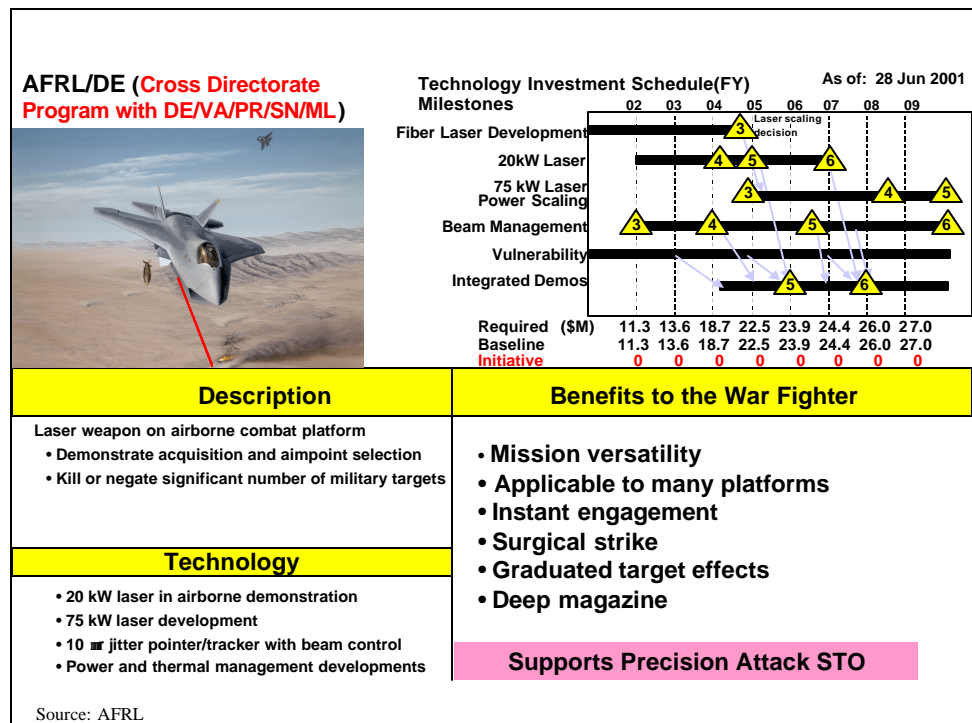

Figure 45. Tactical HEL Weapon – Joint Initiative

Initial study indicates that development of a useful tactical HEL is feasible, and initial budget estimates have been generated. In the near-term, air-to-air mission capabilities and applications will likely evolve more quickly. However, offensive and defensive, target detection, and target destruction benefit—both air-to-air and air-to-ground—could be achieved in the not-to-distant future. The maturation of the tactical HEL subsystems must progress to TRL 6 for HEL functionality to be successfully demonstrated. Progression to TRL 6 can be accelerated and leveraged directly from the Airborne Laser program, the Airborne Tactical

Laser effort, and AFRL joint directorate efforts coupled with DoD and contractor research and development.

Further study to quantify HEL target-threat vulnerability is needed in order to assess the real feasibility and value of a tactical HEL system. In addition, these data will enable system optimization through a series of trade studies on cost, weight, and performance. By quantifying the specific values of HEL energy on various targets (detection and destruction), the warfighter could pre-plan tactics for using laser sensors and weapons for multi-role mission optimization. Moreover, future tactical HEL studies should expand the Tactical HEL Fighter mission utility and life-cycle cost benefits to the warfighters and their operational commands.

TASK FORCE FINDINGS

1. With technology investment, an HEL fighter could be ready for EMD in approximately 10-15 years. Key technical development needs include significant improvements in the power-to-weight/volume ratio of the laser system, beam control in a high vibration/acoustic environment, and thermal management.
 - Nearer- term applications at low and moderate power levels (1 KW to 30 KW) are both possible and highly desirable. They will allow fuller understanding of the benefits of lasers in the tactical environment, assuming the challenges of scaling and packaging are solved.
 - These applications may include advanced sensing, aircraft protection against surface- and air-launched missiles, and air-to-air combat.

FUTURE COMBAT SYSTEM APPLICATIONS

The Army is in the process of transforming its force so that it will be better positioned to address 21st century challenges. The end result will be a force that is more responsive, deployable, agile, versatile, lethal, survivable, and sustainable. The Army Vision, announced in October 1999, is to transform the Army into a strategically responsive force that is dominant across the full spectrum of operations. The transformation will take place along three major paths: the Objective Force, the Legacy Force, and the Interim Force, as shown in Figure 46.

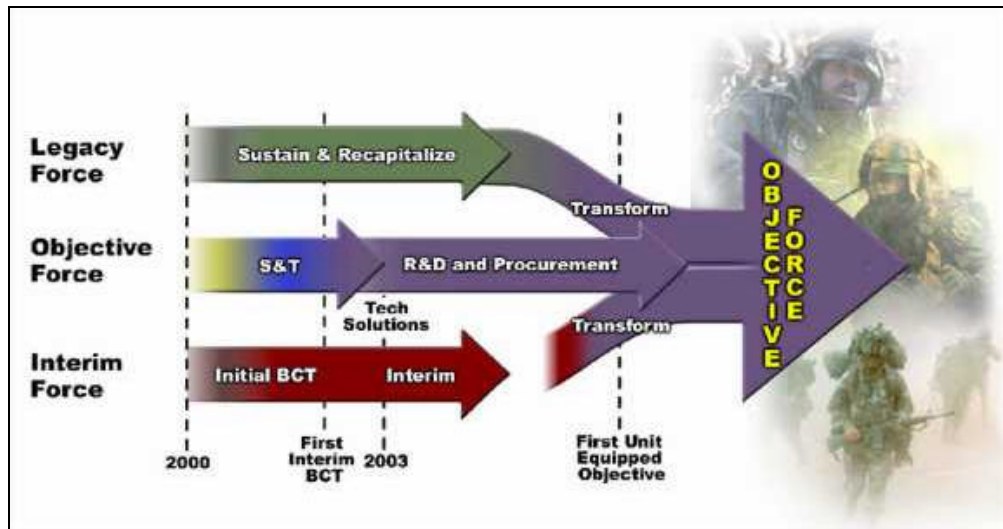

Figure 46. The Army Vision

THE OBJECTIVE FORCE

The critical transformation path leads to the Objective Force. A key characteristic of this force is the ability to rapidly deploy a combat-capable brigade anywhere in the world in 96 hours; a division on the ground in 120 hours; and five divisions on the ground in theater in 30 days. This rapid deployment capability is based on using the C-130 as the guideline for systems transport. This guideline limits vehicle weight to no more than about 20 tons in 300 to 400 cubic feet of volume. Deployability is the first step in transforming the Army from a heavy, slow-moving, overmatched force to a light, quick, and lethal force.

However, dominance requires more than just getting there. Advantages in maneuverability, precision engagement, focused logistics, and full soldier and asset protection are also essential. To counter expected threats, a combat “team of teams” has to evolve—one that will generate overmatching firepower and maneuverability. Combat power will be derived from a combination of maneuverability, firepower, and force protection guided by command leadership.

FUTURE COMBAT SYSTEMS

One key to the success of the Objective Force is a concept called Future Combat Systems (FCS). FCS is the goal of a collaborative FY 2000-2005 DARPA/Army Technology Program that views technology as an “accelerator” for the Objective Force. The desired capabilities of the

FCS are to have unrestricted transportability and deployability to and within the theater, to significantly reduce supportability requirements, to provide unprecedented lethality and enhanced survivability, and to have superior battlefield mobility.

The DARPA/Army collaboration is focused on the high-risk, innovative approaches that can make the FCS a reality. Currently, four contractors are involved in competitive concept development. While the final concepts are not yet known, both DARPA and the Army are stressing beyond-line-of-sight engagements, robotics, and layered active protection of a netted force. The program will evolve into a series of system demonstrators based on a technology readiness decision in FY 2003. The demonstrators will lead to a system development and demonstration decision in FY 2006 with a projected low-rate initial production in FY 2008. Recognizing the risk involved in fully achieving the objectives the first time out, block upgrades are projected.

HIGH-ENERGY LASERS AS A PART OF FCS

While each of the seven characteristics of the Objective Force is equally important, versatility seems to be the key for the role of high-energy lasers. The need to reduce both the deployability and sustainability footprint dictates that single-purpose elements in the force will be difficult to justify. Rather, elements that can contribute in many different ways to the force capability will be of the most value. Potential uses for HELs in the FCS are described below.

Counter-Surveillance

The FCS-equipped force must win the reconnaissance battle. Lasers are useful for denying surveillance by electro-optical systems and for denying surveillance by area coverage assets, such as satellites and unmanned aerial vehicles (UAVs) equipped with imaging devices. HELs accompanying the force could either dazzle (jam) imaging systems in a reversible mode if desired or could be used to destroy the imaging sensor.

In the case of UAVs, high-energy lasers could destroy the platform at extended distances. On the ground, lasers on manned or robotic vehicles could use optical-augmentation techniques to locate electro-optic surveillance devices.

Active Protection

High-energy lasers can contribute significantly to a layered active protection system. HELs mixed in the force could, if cued by a satisfactory fire control system, destroy precision munitions after deployment but

before they could lock on and engage an element of the force. HELs on the periphery of the force—perhaps in robotic vehicles—could detect the firing of long range Airborne Tactical Countermeasures Systems (ATGMS) and destroy the missiles before any losses occur. Smaller packages, onboard selected vehicles, could engage short-range missiles as a part of the vehicular active protection system.

Air Defense

High-energy lasers are ideal for protecting the force from air attack either by fixed wing aircraft or rotorcraft. In the case of attack by unguided rockets, mortars and artillery, high-energy lasers could provide substantial protection to the force by selective engagement of parts of salvos. Such a capability would be extremely valuable when the FCS-equipped units are in defensive position during periods of crew rest.

Mine Clearance

An option open to an adversary to deal with a force of superior mobility is the use of minefields—particularly scatterable mines. Robotic HEL-equipped vehicles for clearing lanes could lead an FCS-equipped force through these minefields with both speed and relative safety.

HIGH-ENERGY LASER SYSTEM CHARACTERISTICS

In order to be a contributing member of the FCS-equipped force, the HEL will have to satisfy the same requirements as the rest of the force—particularly for mobility and deployability.

Mobility

The FCS HEL must be able to move with the force, both within and to the theater, and must be capable of fighting immediately upon arrival in theater. Therefore, the system must fit within the C-130 form factor, fully loaded. For a variety of reasons, including vehicle maintenance, an HEL weapon needs to be designed so that it can be integrated into nearly all FCS platforms. The details of those platforms are unknown at this time.

Sustainability

It is desirable that the systems present as few unique resupply issues as possible. Systems with significant resupply needs are going to have to be correspondingly more effective in order to justify their presence in the force.

Weapon Characteristics

There is no single set of weapon characteristics that fit all of the situations described above. In general, the more difficult of the potential functions will require laser power of a few hundred kilowatts. The amount of power required is primarily driven by the need to operate at a few tens of kilometers against the softer targets such as UAVs and between 5 and 10 kilometers against the harder targets such as rockets, mortars and artillery. The exact power levels will be determined largely by the area coverage (range) required of the system, which will be based on the observe & orient concept. Magazine depth (or duty cycle) is another sensitive issue. Deployments of a few or single HELs to cover the force or substantial parts of it, will stress higher powers, longer ranges, and deeper magazines (higher duty cycles). Concepts with more, widely deployed HELS will be substantially less stressing on the technology.

Time Frame

On the present FCS schedule, inclusion in the first increment of FCS requires that the system be at a reasonably high Technology Readiness Level (6 or 7) by 2004-2005. All of the HEL technologies being considered are ready to move to a >100 KW mobile demonstrator phase in time to produce a system ready for experimentation by 2006 or 2007. All of the technologies could be available in mature form for the first block upgrade (FY 2014).

CANDIDATE LASER TECHNOLOGIES

Of the currently available high-energy laser technologies, the solid-state heat capacity laser (SSHCL) or some closely related variant, is the obvious candidate. If it is successfully scaled up as currently envisioned, it can easily fit the required form factor and would require only the same fuel as all other vehicles in the force. By its nature it appears to have considerable flexibility in packaging and use. The SSHCL is also desirable because of its wavelength—around 1 micron. Most of the important optical train parameters scale with this wavelength. The most significant concern with the SSHCL is how the size and weight will scale if high-duty cycle operation is required. Magazine depth is inherently large if the system can wait long enough before the next engagement. But lengthy, rapidly repeating engagement sequences could drive the size and weight out of the supportable realm due to cooling and electrical power requirements.

There is clearly an important trade to be made between the number of systems and the size of the individual systems.

Current deuterium fluoride technology is the most mature due to the significant advances made in the THEL ACTD. Systems engineering studies over the next year will address the size and weight issues, but reduction to FCS-compatible size and weight is clearly a major challenge. The longer wavelength (while a benefit in propagation) makes the optical components the largest of the three technologies. DF also suffers from the requirement for unique fuels. Although considerable progress can clearly be made in packaging the fuels system, elimination of the need for resupply of unique fuels is not in the cards. However, subject to fuel resupply, a DF system can have an arbitrarily deep magazine. DF technology may still be a candidate for a role in the Objective Force, if not as an FCS component.

Chemical oxygen iodine laser technology is also a candidate and lies somewhat between the technologies previously discussed. COIL operates at a wavelength close to one micron, and so benefits from the smaller scale of the optical components. COIL is a chemical laser technology, so does have a requirement for unique fuels. However, a closed-cycle COIL has been demonstrated in which the exhaust products are captured, and analysis has indicated that recycling the chemicals is feasible. Thus, a COIL-based system may yet satisfy some or all of the FCS requirements. Clearly more work is needed to resolve this issue.

FIRE CONTROL TECHNOLOGY

Substantial progress had been made in the THEL ACTD in developing an operational fire control system. However, it is still far short of that needed to satisfy potential FCS missions. The ACTD equipment is large, bulky, and suitable for static operation. It has been closely tailored for the rocket threat and has several safety features that prevent it from engaging threats included in the FCS scope. In addition, testing to date has largely been restricted to the Israeli situation and conditions at the test range. In spite of these shortcomings, much has been learned about the value high-energy lasers can bring to a dynamic battlefield.

The design and development of a competent fire control system—including the beam director, sensors, illumination and tracking adjuncts, command and control software, and external acquisition sensors—is likely to be the pacing factor in incorporating high-energy lasers into the FCS concept. The flexibility and agility required of the HEL system by the wide variety of threats and threat conditions will require substantial effort in both control software and the man-machine interface.

Each of the potential demonstrators described in earlier sections can contribute to the development of a portion of the overall system. A major technical issue is how to preserve those lessons learned.

A dedicated fire control system test bed may be required that includes capability ranging from a systems integration laboratory and a virtual man-in-the-loop simulator to a mobile test bed that can be used in field exercises and tests without the restrictions inherent in a high-energy laser. Much remains to be learned about how this could be done.

S&T NEEDS FOR ARMY APPLICATIONS

Low-Cost Beam Control for Army Systems

A low-cost, robust beam control subsystem is needed. Current HEL beam control subsystems are fragile and high cost. The additional complexity of an adaptive-optic capability may need to be incorporated into the beam control subsystem, depending upon the results of the lethality and atmospheric propagation studies. Key beam control issues the Army must address include:

- Low-cost options that offer less than 5-microradian pointing and tracking accuracy. While trade offs between weapon output energy, beam quality, and propagation are complex, a significant factor will be the cost of a beam control subsystem.
- A variety of adaptive optic technologies should be investigated, including single-surface faceplates, multiple-surface faceplates, and electronically steered arrays. Coatings and optical materials suitable for use in the Army battlefield should also be pursued.

Solid State Laser Technology for Army Applications

The Army's point design concept for a 100 KW SSL integrated on an electric High Mobility Multi-Purpose Wheeled Vehicle (HMMWV) identifies the electrical power and thermal management subsystems as major mass components, comprising about 75% of the total HEL mass. Conceptual analysis indicates that for a given magazine depth the mass of the prime power subsystem and the thermal management subsystem scale nearly linearly with HEL output power. This emphasizes the need to make technology investments to significantly reduce the mass of these subsystems.

The mass of the prime power subsystem is made up almost entirely of batteries. While the Army has identified some relatively near-term technology—such as the ultra-high power (UHP) Lithium Ion based technology that projects >20 KW/kg and 215 kJ/kg—there are still issues that remain. Key power subsystem issues the Army must address are:

- The UHP Li Ion battery technology must be brought to a maturity that will support a demonstrator HEL SSL weapon system in the

relative near term, and support a potential multiunit procurement in the longer term. This must be done under the constraint that the batteries must be affordable in quantities of interest to the Army for future applications.

- Alternate prime power sources compatible with the laser diode load characteristics and supportable by the Army in a field environment must be explored. While batteries more advanced than the UHP discussed above could offer advantages, the Army should engage the research community in a thorough evaluation of long-term technologies.

To address managing the waste thermal energy, the Army's microchannel cooler design for removing the waste thermal energy from the laser diodes has been demonstrated at the required levels. Rapid removal of the waste thermal energy from the Nd-GGG laser material currently limits the duty cycle for the HEL weapon, which limits the HEL weapon's utility. Key thermal management subsystem issues the Army must address include:

- Rapid removal of the waste thermal energy from the Nd-GGG laser material using advanced approaches such as that being pursued using mist cooling are needed. Mist cooling must ensure that the laser material is not adversely effected due to particulate deposition or fracturing.
- An intermediate heat sink capable of rapidly absorbing the waste heat prior to its being dumped into the environment must be developed. Latent heat of fusion or vaporization may offer the best intermediate heat sink for the rapid deposition of the waste heat removed from the laser subsystem. The Army has identified a commercially available solid that offers promise as a near-term heat sink. However as laser powers increase the mass of this material may exceed the platforms' ability to support it. The Army must pursue other approaches to a heat sink, possibly examining the use of the latent heat of vaporization of an appropriate fluid.

Additional Army SSL S&T needs identified include the following:

- Laser pump diodes appear, based on preliminary data, to be within the state-of-the-art to meet the Army's technical performance requirements. However, the cost in terms of watt of output energy must fall by over an order of magnitude to be affordable for an Army ground weapon system. The primary cost driver appears to be the microchannel cooler manufacturing. Low-cost alternatives to the present technology must be identified and demonstrated.

Lethality and Countermeasures for Army Applications

Threats of interest to the Army include UAVs, ground tactical targets, fixed and rotary wing aircraft, ATGMs, precision guided munitions, cruise missiles and rockets, artillery, and mortars (with or without submunitions), and space-based ISR systems. Many of these threats have not been studied in any detail for tactical laser lethality effects.

It is important to address the lethality issues of both the CW and pulsed lasers as potential application to tactical laser system, as the Army is pursuing both options. Ultra-short pulses lasers ($<10^{-12}$ s) operating at ultra-high intensities ($>10^{15}$ W/cm²) are not in the scope of the current Army program.

The detailed threat set of concern to the Army is composed of a large number of weapons including myriad rockets, artillery projectiles, and mortar rounds of differing design and manufactures. While designs can be known, in the Army scenario for operations the HEL weapon must have assured lethality in the absence of specific detailed threat information. To achieve this the Army must develop HEL weapons that assure lethality against less than fully described threats in a battle environment where HEL beam propagation is likewise not fully characterized.

Key lethality tasks to be addressed in the Army HEL program are to:

- Define threat potential vulnerabilities based upon available data.
- Perform threat vulnerability analysis to define the laser energy parameter space.
- Characterize material and system response (painted metals, composites, glasses, plastics, advanced materials, sensor components).
- Identify target damage modes and measure energies required for lethal damage (rapid cook-off, burst, melt-through, structural collapse, fuses, sensors and optics).
- Define target performance after HEL irradiation.
- Validate lethality models using analytical and experimental data.
- Link the lethality data to the mission analysis models with particular emphasis on engagement scenarios.

The Army must understand and demonstrate the lethality of HEL weapons in a tactical battlefield environment. To achieve that objective the Army must focus an S&T effort on:

- Modeling the time-dependent thermal and hydro-thermo-mechanical effects. Energy deposition, heating materials, material removal, internal pressure generation and aerodynamic loading as a function of applied and coupled energy, and the effect of

wavelength and CW and pulse waveforms must be effectively modeled from first principles and validated by experimental data. Once anchored, this model will give the Army a robust capability to predict the lethality of its HEL weapons in a variety of scenarios when coupled to a propagation model.

- The effect of battlefield aerosols—either naturally occurring, artificially created as a countermeasure, or the collateral effects of other battlefield activity—must be modeled as a part of the lethality investigation. Battlefield aerosols can reduce the effective range of the laser by either scattering energy out of the beam or absorbing energy from the beam. These effects are both wavelength dependent and wavelength independent and thus sensitive to the choice of laser type. Additionally, the impact of reduced range has to be understood in terms of the concept of operation of the force and the concomitant effects on the weapons and sighting systems of the opposing force. Potential trade-offs between force spacing and positioning to mitigate the reduced ranges need to be clearly understood.
- Target response during and following HEL irradiation, in terms of munition detonation and deflagration, can be modeled using existing explosives databases. Negation of precision-guided munition sensors and the effect on munitions performance will be system specific, and significant testing will be required to establish a sufficiently representative database to allow reliable predictions of lethality. Blinding and destruction of ISR sensors is also system specific, and a significant test program will be required to establish thresholds for blinding and destruction. Destroying air vehicles using HEL weapons that are built on detailed threat designs used to identify vulnerable locations will provide the Army a detailed database to identify aim points.

Potential adversary countermeasures have not yet been systematically studied for the Army threat set. However, there are other past and ongoing studies that will be leveraged to address the countermeasure issues. Areas to be addressed include such technologies as wavelength blocking filters, thermally resistant coatings, reflective coatings, and tactics and doctrine.

SUMMARY

There are significant opportunities for the contribution of high-energy lasers to the Objective Force as part of the FCS. The risk inherent in exploiting lasers for this purpose is about the same as that associated with

many other key FCS technologies. It is reasonable to expect that, with support, one or more of these technologies will mature in time to participate in the block upgrade to FCS.

TASK FORCE FINDINGS

1. Given developments that provide the needed deployability and battlespace mobility, HEL systems can contribute significantly to FCS concepts in the areas of counter-surveillance, active protection, air defense, and clearance of exposed mines.
2. A relevant system—based on an SSHCL, DF laser, or COIL—could be ready for experimentation by about 2006, if funded.
3. The Army's solid-state laser technology program, albeit immature, shows great promise as a technology that could significantly enhance the Objective Transformation Force while meeting the needs for mobility and supportability.
4. The Army's programmed investment in solid-state HEL weapon systems, in particular the 100 KW demonstrator, is inadequate to move this technology to sufficient maturity to support an acquisition decision this decade.
5. The operationally limiting factor for the SSHCL is duty cycle. The operationally attractive factor is the use of fuels common with the rest of the force.
6. The constraining challenges for the DF laser are size, weight, and the need for fuel resupply and a pressure recovery system. The advantage of DF technology is its demonstrated maturity.
7. The effects of the battlefield environment on the effectiveness of a force using high-energy lasers are yet to be fully understood. Significant efforts are needed in order to make proper trade-offs between the choice of laser type and concepts of operations as a function of threat tactics.
8. Sealed exhaust COIL technology would become competitive given the successful demonstration of an HEL Fuel Recovery System.
9. Fire control will be a major challenge for HEL contribution to the FCS. The fire control technology developed for the THEL ACTD is a good start towards meeting FCS requirements, but further progress will be needed in size and robustness.

COUNTERMUNITIONS

The Army Space and Missile Defense Command, in cooperation with the Navy, has developed a high-energy laser system capable of neutralizing surface-laid mines and unexploded ordnance (UXO) such as artillery rounds, mortar rounds, rifle grenades, and large general-purpose bombs. This system, named ZEUS™, is a self-contained, high-powered laser integrated on an HMMWV. An operational concept for a 1 KW ZEUS™ is shown in Figure 47. A prototype 500 W laser has been successfully tested at Nellis Air Force Base using military operators. This system is currently being upgraded with higher reliability diodes, and is scheduled to perform a supply route clearance demonstration using advanced Global Positioning System (GPS) targeting. Also, in FY 2001, the process to upgrade the system to a 1 KW solid-state laser has begun.

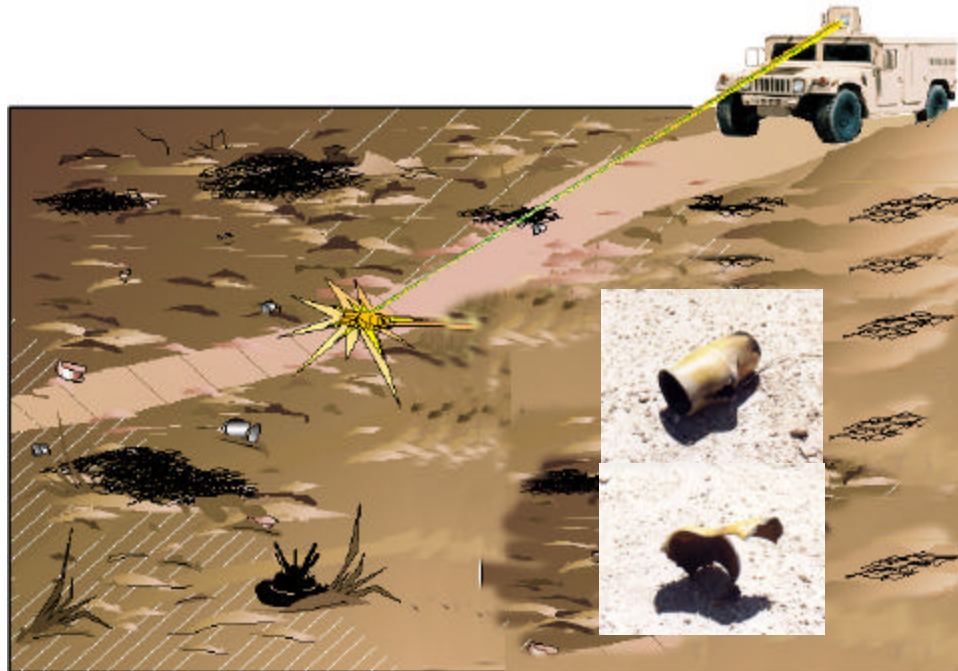

Figure 47. ZEUS™ Operational Concept

ZEUS™ uses a visible-wavelength sensor to perform surveillance and a high-power laser to destroy targets at ranges up to 300 meters. Availability of an external precision cueing system would significantly speed up the acquisition process. After a target is acquired, the operator zooms the camera onto the target and selects an aim point. The operator then turns on a visible-designation laser and radiates the target with the HEL beam until the target is neutralized. Specific advantages of the

system include greatly enhanced safety over existing removal procedures and a low-yield detonation of mines and UXO.

ZEUS™ will use either the currently available 1 KW slab laser technology or an emerging laser rod technology. The system will rapidly neutralize landmines and UXO by irradiating the target until the explosive filler material is heated beyond its combustion temperature. If the UXO has a metallic case, the laser energy is conducted through the case to the explosive filler material. There is no requirement that the metal case be penetrated to ensure neutralization. If the UXO has a plastic case, the laser radiation burns through the combustible plastic and directly ignites the explosive filler. Since the neutralization mechanism depends on initiating combustion of the explosive fill, the type of fusing is irrelevant. The overall effectiveness of the system is extremely high, on the order of 97 percent, when detected.

The ZEUS™ system consists of the following seven subsystems, illustrated in Figure 48:

- The Fire Control Subsystem uses a PC-based computer to control the laser and to display the target scene. This allows the operator to designate the target with a joystick based on an image displayed on a flat-screen display.
- The Laser Device Subsystem (LDS) is a diode-pumped Nd:YAG laser, which produces radiation at 1.064 micron in a quasi-CW waveform. The laser device subsystem includes the high-power and designation lasers, beam-combining optics, beam dump, and beam expander. These are mounted vertically on a composite optical bench, and are sealed and rigidly attached to the Beam Control Subsystem to reduce the potential for beam misalignment.
- The Laser Power Subsystem (LPS) consists of the laser power supplies and diode drivers that provide the proper current, voltage, and pulse length to the LDS. The LPS is powered by the prime power subsystem. The shock-isolated LPS is mounted on standard racks in the rear passenger compartment behind the driver.
- The Prime Power Subsystem consists of an AC 60 Hz alternator, which is powered by the power take-off that is mounted on the HMMWV transmission. Future design enhancements will include a towable generator to eliminate the need for a specialized power take-off design.
- The Beam Control System (BCS) delivers the laser beam radiation onto the target through the 15 cm optical train. The actively stabilized BCS can engage targets at azimuth angles of $\pm 150^\circ$ and elevation angles of $\pm 20^\circ$.

- The Waste Heat Subsystem provides the coolant for the LDS and LPS at a fixed set temperature between 20 and 30°C within a tolerance of 0.2°C.
- The Armored Vehicle Subsystem is an uparmored HMMWV, which has air conditioning and armor protection for the crew compartment in all directions. Laser safety-coated plastic has been placed on all windows so the driver and operator are protected from reflected laser radiation and do not have to wear laser safety goggles.

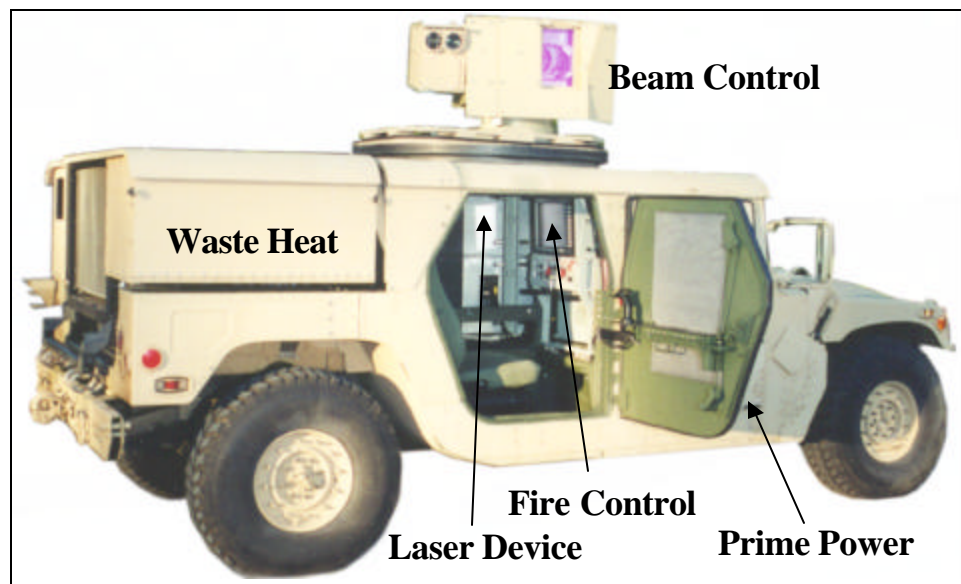

Figure 48. ZEUS™ System

The overall goal of the system is to demonstrate a reliable and effective tool for neutralizing unexploded ordnance. Specifically, the goals are to:

- Demonstrate the overall system reliability under military use.
- Demonstrate reliable diode performance with long lifetimes.
- Demonstrate minimal maintenance for the diode-pumped laser device.
- Demonstrate reliable laser output power and beam quality.
- Demonstrate the capability to engage a wide variety of UXO targets in short engagement times.
- Determine the time required to neutralize a variety of UXO munitions under different environmental conditions.
- Determine cost savings per UXO neutralization.

The ZEUS™ prototype has been tested at Test Area 6 at the Redstone Technical Test Range and at Nellis Air Force Base, Nevada. In testing from May to October 1999, over 500 mines and UXO were successfully neutralized. Munitions were engaged at ranges of 30 to 250 meters and engagement angles of 30, 60 and 90 degrees.

The road ahead for a ZEUS™-like fielded capability is not yet clear. Two courses are under consideration: procure a near-term capability to support existing forces or incorporate the capability as part of the HELSTAR.

TASK FORCE FINDINGS

1. The ZEUS™ system, integrated onto a HMMWV, provides a capability to neutralize surface mines and unexploded ordnance. A prototype 500-watt laser has been tested. A program is underway to upgrade the system to 1 KW. The system could be procured as a near-term capability or be incorporated as part of the HELSTAR.

MARITIME SELF-DEFENSE

The littoral warfighting environment offers many challenges to the Navy, as Figure 49 depicts. Current naval engagement options using shipboard weapons systems are almost exclusively kinetic. Although inherently effective at delivering energy (given a hit), current kinetic or hard-kill weapons effectiveness can be severely reduced when reaction time is compressed, and when hostile forces are highly maneuverable or located in close proximity to non-targets. Generally, these weaknesses are manifest at the edges of the current threat envelope, such as with high speed, maneuvering, radially inbound anti-ship cruise missiles, and asymmetric targets in the littorals such as small and/or fast patrol boats.

Relatively soft asymmetric targets, such as patrol boats, are often difficult to engage effectively when in close proximity to friendly or neutral forces. They have the ability to blend in with commercial and pleasure craft and are thus quite difficult to discriminate from non-threats. Even when discernable as a threat, engagement of such targets when in the vicinity of friendly or neutral forces requires more precision than is typically available with explosive ordnance.

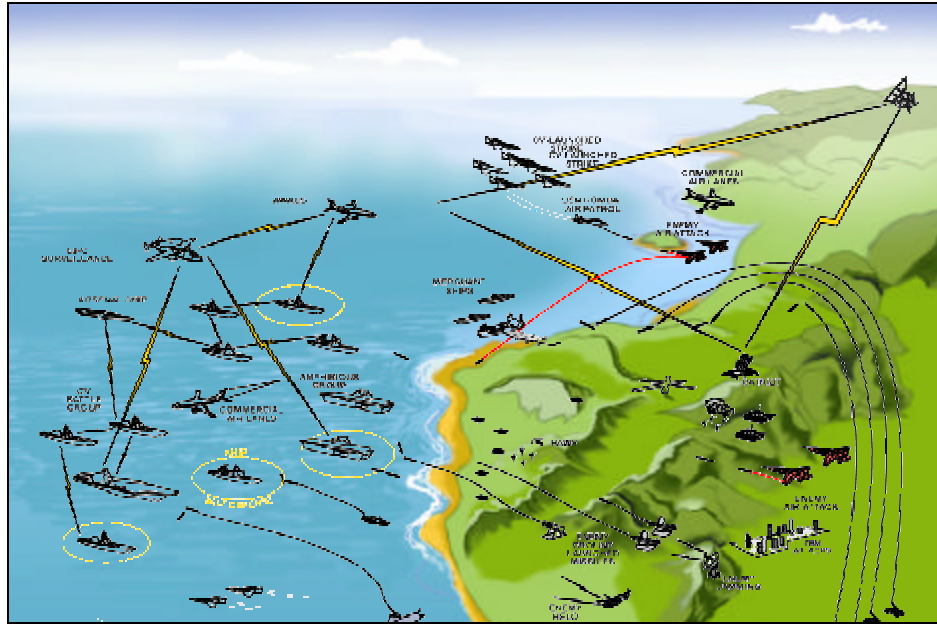

Figure 49. The Littoral Warfighting Environment

A Navy high-energy laser weapon system would have to include attributes enabling engagements over a wide spectrum of threats and threat scenarios. In some scenarios, hostile forces may be engaged only by using some variation or combination of directed-energy weapons to deliver a precision hit on the target. A properly designed high-energy laser weapon system would need to be able to deliver the required level of lethality in a precise manner. This combination of precision and accuracy tends to force system designs that exhibit a significant level of discrimination capability—an attribute often undervalued when considering the overall utility of a system.

In addition to the precision engagement capability, one of the strongest attributes of a high-energy laser system is the ability to use its optics (telescope) for identification. The Sea Lite Beam Director at the White Sands Missile Range in New Mexico is already being used to monitor missile engagements at significant ranges. The ability to positively identify a contact at such ranges is quite possibly the most underrated attribute of a high-energy laser weapon system, and would likely become the most commonly used capability of such a system.

NAVY PLANS

The Navy has developed a research and development roadmap that could lead to arming future ships with solid-state and/or free-electron lasers. Initial efforts will be focused on the unique requirements of the

littoral environment and will include work in the areas of maritime propagation, lethality, laser source development, and systems engineering. Air at sea level is thicker than that on the ground or in the sky, making the Navy's challenge of propagating a laser beam different from that confronting the other Services. Maritime propagation work will determine the specific atmospheric windows through which a laser beam can penetrate and reach its target without being absorbed under various conditions. This will be discussed in more detail in the following chapter.

The lethality requirement is driven by the need to penetrate and/or destroy a wide range of materials of which the threat spectrum is made. The Navy will continue to investigate the benefits that may arise from the use of various pulse formats, peak powers, pulse trains, and wavelengths, to determine the optimal lethality mechanisms for various materials and targets.

The Navy's decision, early in 2000, to adopt an electric drive propulsion system for DD-21 and follow-on ships makes free-electron laser and solid-state laser technologies the most sensible choices for a laser source for naval ships. Though both offer the benefits of using electrical pumping mechanisms, both also have challenges unique to their design. The solid-state lasers will need to overcome the thermal loading that a multi-megawatt system will place on the laser medium. The free-electron laser source will require high average current injector work, as well as work on high-power optical resonator mirrors and an electron beam transport system. Currently the Navy is funding the free-electron laser development at Thomas Jefferson Lab. The free-electron laser offers the wavelength variability that may be required in order to propagate a high-power laser beam through the atmosphere under various conditions.

Systems engineering work is primarily focused on reducing the overall size of any high-power laser source so that it can fit into the available real estate of a Navy ship. Current laser sources and the support systems for those sources have not been designed for the confines of a ship, and substantial engineering work will be necessary to successfully integrate a laser system into naval crafts.

Since the U.S. Navy operates fundamentally as a forward-deployed force, all Navy equipment is subject to the harshest of marine environments, which causes significant concern about using electro optics aboard ships. Reliability, maintainability, availability, survivability, vulnerability, producibility, supportability, and transportability are chief contributors to the life cycle costs of Navy systems. Additional challenges include electromagnetic compatibility, human engineering, health and safety, system security, operability, testability, contamination control, and mass properties. The bottom line is that in order to address these essential issues, the development of a high-energy laser weapon system requires a "top-down" system approach rather than the bottom-up science and

technology approach that has been used historically. For example, logistic support issues currently constrain serious consideration of chemical-laser-based high-energy laser weapon system concepts.

Because of the harsh marine environment, a Navy high-energy laser weapon system can and should be used in conjunction with current kinetic kill systems to improve the overall engagement probability of kill. The introduction of an HEL into the engagement equation would significantly extend the capacity and capability of existing kinetic options by neutralizing certain target capabilities such as high-G maneuverability. In addition, since the reaction time of a "speed-of-light" system will theoretically exceed any kinetic alternative, given sufficient lethality, some of the advantage gained by enemy stealth techniques used to shorten reaction timeline can be recovered. In other words, properly integrated into a combat system, a Navy high-energy laser weapon system has the potential to allow for better utilization of existing assets, thus reducing operational cost. Most importantly, the combination of kinetic and HEL kill systems has the potential to provide an effective shield around surface units against many known and potential hostile threats.

TASK FORCE FINDINGS

1. A properly designed high-energy laser weapon system could be a highly flexible naval capability for needs ranging from testing hostile intent to lethal engagement.
2. Given the difficulty in handling laser chemicals shipboard and the electrical power available on modern Navy ships, the family of electrical lasers, including free-electron lasers and solid-state lasers, are logical candidates for maritime self-defense.

LARGE-AIRCRAFT SELF-DEFENSE

With time, access to theater basing for tactical operations may become difficult to obtain, and if such basing is available, it may become vulnerable to attack by enemy theater ballistic missiles. Under those circumstances, using long-range aircraft, such as bombers, to conduct theater strike operations may become an important capability for countering aggressor offensive operations. However, lack of theater tactical air assets may make such strike operations vulnerable to enemy tactical air or to enemy surface-to-air missiles.

To counter these vulnerabilities, a large-aircraft self-defense capability may become very important. Directed-energy laser defensive systems carried on bombers offer an opportunity for a self-defense capability. The larger size and payload of bombers should make high-energy laser defenses much easier to achieve than will be the case for tactical fighters.

An attractive large-aircraft laser defense system could employ electrically powered solid-state laser phased arrays. Such systems could be powered by the aircraft's gas turbine main propulsion systems, which are typically capable of generating on the order of 100,000 horsepower. During cruise flight, a substantial fraction of this power—perhaps on the order of 10 megawatts of electrical power—should be available to power a laser defensive system. This, in turn, could generate up to several megawatts of laser power using solid-state laser diode arrays. The laser beam could be formed by employing phased arrays of laser diodes located at several locations on the bomber to provide all-around coverage. The fuel supply of the bomber would provide for a very deep magazine supply compared to that of a chemical laser. It is also much safer.

Defensive operations, as described here, would probably be carried out at relatively short ranges of 10 to 20 kilometers against relatively soft targets. As a result, the size of the phased array apertures could be modest, perhaps 10 to 20 centimeters, and the power levels modest as well, perhaps a few hundred kilowatts.

The viability of this application depends on a significant investment in the technology and low-cost production of laser diode arrays. It also requires solving the problem of phasing up such an array to generate a well-focused beam. An ancillary problem that needs a solution is that of threat detection and accurate targeting. This might best be achieved through the use of an optical radar surveillance and targeting system, since the necessary targeting precision may be greater than that which can be achieved by microwave radar.

OPERATIONS OTHER THAN WAR

Operations other than war present some of the most complex situations to local commanders. Such operations can range from crowd control to counterinsurgency to counterterrorism and involve a balance between the need to peacefully control the situation and concerns for protecting the troops and preventing unwanted destruction. The need to achieve this balance has led to an increased interest in non-lethal weapons.

Rules of engagement in operations other than war will often prohibit the use of lethal force. In such cases, the availability and employment of non-lethal weapons could provide tactical commanders another valuable tool for performing difficult missions. Laser weapons, including high-energy lasers, can be used for this purpose. The DoD definition of non-lethal weapons shown below calls for minimizing fatalities, not ruling out the possibility that some will occur.

3.1. Non-Lethal Weapons. Weapons that are explicitly designed and primarily employed so as to incapacitate personnel or materiel, while minimizing fatalities, permanent injury to personnel, and undesired damage to property and the environment.

3.1.1. Unlike conventional lethal weapons that destroy their targets principally through blast, penetration and fragmentation, non-lethal weapons employ means other than gross physical destruction to prevent the target from functioning.

3.1.2. Non-lethal weapons are intended to have one, or both, of the following characteristics:

3.1.2.1. They have relatively reversible effects on personnel or materiel.

3.1.2.2. They affect objects differently within their area of influence.⁷

Lasers have previously been discussed as potential non-lethal weapons when used in the role of a dazzler. This type of application usually calls for low-power lasers of milliwatts to a few watts at most. High-energy lasers can also be used in a controlled way so as to achieve the intent of non-lethal weaponry through a careful selection of the targets and execution of precisely controlled engagements.

POTENTIAL ENGAGEMENTS

Laser weapons can be used in many scenarios, but a likely one is in urban or built-up areas where there are large numbers of people. A key element of such scenarios is often the presence of both combatants and noncombatants in close proximity. Actual situations can vary from a large agitated crowd on the verge of a riot to a hostage situation protected by armed combatants.

The use of non-lethal lasers is highly situation dependent. In the case of crowd control, one could focus on an object that is naturally a part of the scene and create an unusual or unexpected effect that distracts or confuses the crowd. This might entail setting small fires in the midst of the crowd or on nearby buildings, disrupting electricity or lighting, collapsing poles or overhead structures, or puncturing containers that would leak liquids or obnoxious aerosols in the vicinity of the crowds. Causing

⁷ DoD Directive 3000.3, "Policy for Non-Lethal Weapons," July 9, 1996.

discomfort or consternation in selected individuals by heating articles of clothing might also be considered.

If weapons or other military objects such as radios (or commercial devices such as cell phones or public address systems) are involved, the key effect could be to render those devices inoperable or to cause them to malfunction. Actions with easily observed effects such as smoking, becoming hot to the touch, or venting gas or liquids would be most effective.

In a hostage situation, the set of potential targets expands considerably. In addition to the specific weapons of the combatants, there may be vehicles that could be disabled by puncturing tires or fuel tanks. Fires or infrastructure attacks can be used to induce the enemy to leave the building or support direct action to free hostages. Disrupting communications by cutting antennas may halt hostage movement, opening up the opportunity for direct action.

It is also essential to include force protection measures in the mix—particularly if they can be accomplished with the same system. Some examples are remote removal of explosives or mines or direct destruction of threat projectiles to prevent base camps from being shelled with mortars or rockets.

SYSTEM CHARACTERISTICS

The primary characteristics of a high-energy laser system capable of supporting the type of engagements described above are excellent beam control, flexible fire control, and variable, repeatable control of the power level. It is desirable that the engagement not be easily observed—that the laser line not be visible; that the engagement be accomplished from outside the immediate, observable area; and that the lasers not provide any obvious signature while in operation. The essential feature is that the effects not have any forewarning or obvious cause-and-effect relationship that can be mitigated.

The power required for the effects described are small as compared to other high-energy laser applications. Deposition of a few kilojoules will be sufficient in most cases to generate the desired effect. Delivery of the energy over a few seconds should be acceptable in most cases (although shorter will usually be better), and large spot sizes are not desirable in most cases. This implies that powers of a few kilowatts per square centimeter at the target are more than sufficient. The range at which operation is intended will be a factor in the design power of the laser.

The most significant consideration in using high-energy laser systems in operations other than war is likely to be the need to obtain a line-of-

sight to the specific target(s). In urban areas, this means either being in close proximity to the target or having an elevated position. While being close eases many constraints such as jitter control and divergence, it will tend to make the system very obvious and increase the probability of direct attack or effects mitigation. Elevation requires either the ability to operate from the top of buildings or to be on an aircraft—probably a rotorcraft of some type. The choice will determine the range of interest for the laser system. The “close-in” system should not need a range longer than a few hundred meters; the “roof” system may need up to a kilometer of range. The airborne system has a much larger potential range and a much harder pointing and tracking problem.

Holding the beam within a few centimeters of the desired aim point from a few hundred meters dictates alignment and jitter control of a few tenths of a milliradian. Increasing the range to 10 kilometers will move the requirement into the tens of microradians. Beam divergence is likewise sensitive to the range. Turbulence effects are going to increase significantly as the range is extended. The result is that systems with wavelengths near a micron will need optics sizes of 50 cm or so for the airborne application and may be as low as 10 to 20 cm for the close-in or roof application. For longer wavelengths, the optics scale with wavelength.

Target acquisition and maintenance of track is stressed by the diversity of targets to be considered. Initial acquisition and target selection will certainly be done man-in-the-loop, similar to the method used in the ZEUS™ Demonstrator, which greatly reduces the possibility of collateral damage and allows for instant battle damage assessment.⁸ The operator can decide to reengage or abandon the target as required to accomplish the mission. Maintenance of the track during engagement, compensation for platform motion, and compensation for target motion will need to be automatic. This dictates an imaging tracker that can learn the size and shape of the target during acquisition and will track through the beam optics. A safety system to abort the beam if the line-of-sight is obstructed is necessary to avoid unintended consequences.

The possible systems to support these missions seem to fall in two categories: a portable ground system of a few tens of kilowatts power with optics sized between 10 and 20 centimeters or a rotorcraft system approaching a 100 kilowatts with optics of around 50 centimeters. Magazine size is scenario dependent.

⁸ The Zeus™ Demonstrator concept is described later in this chapter in the section on countermunitions.

CHAPTER III. MAJOR ISSUES

Incorporating HEL systems into military operations is not without challenge. The impact of the environment—in the atmosphere, over land, over water, and in space—on system performance can be significant. Understanding and predicting such impacts, as well as the effects and vulnerabilities of HEL systems, can be important considerations in designing systems, identifying promising areas of technology research, developing concepts of operations, and employing HEL systems on the battlefield.

This chapter describes five areas the task force believes are of most concern in developing and employing HEL systems:

- Atmospheric and propagation concerns.
- Understanding effects and vulnerabilities.
- Modeling and simulation.
- Beam control.
- Laser development.

ATMOSPHERIC AND PROPAGATION CONCERNS

ATMOSPHERIC EFFECTS AND DECISION AIDS

Atmospheric effects dictate the design and performance of almost all high-energy laser systems (SBLs being exceptions). These effects include those common to all electro-optical systems, namely obstruction by opaque clouds, transmission losses from scattering and absorption, and optical turbulence degradation. They also include effects unique to HEL systems, such as thermal blooming arising from molecular and aerosol absorption.

Adaptive optics provides the means to maintain beam quality in the face of atmospheric turbulence. However, such methods are not applicable or completely effective in all situations. Ideal adaptive optics requires a beacon—a point source of light from the target—and this is not completely or even partially achievable in some systems or applications. Furthermore, for long slant or near-horizontal propagation paths, the integrated turbulence strength can be sufficiently strong that even the best adaptive optics cannot completely compensate for the turbulence. Thus the system performance is degraded by the atmospheric turbulence conditions and the limited capabilities of the adaptive optics system.

System performance is significantly enhanced by a capability to model and predict laser system effectiveness under specific atmospheric conditions. Forecasting and decision aids for existing conventional electro-optic systems provide a model for HEL systems. A joint program, involving the Army, Navy and Air Force, has developed and delivered decision aids for systems where atmospheric effects are a concern, including low-light-level TV systems, passive infrared seekers, and laser-guided munitions.

The Air Force Research Laboratory leads the tri-service team that developed the Target Acquisition Weather Software (TAWS) currently in operational use by the Air Force and Navy weather support personnel in both training and strike mission planning. For IR seekers, TAWS uses numerical weather forecasts, real-world target models, and sensor characteristics to produce quantitative predictions of lock-on range. This is accomplished using physics-based models that predict weather effects on target contrast through thermal modeling of targets, backgrounds, and atmospheric transmission. TAWS supports strike mission planning by producing simulations of lock-on range versus time of day or azimuthal angle of attack. The capability is currently being implemented in a mission planning initiative for generating air tasking order. The system enables weather impacts to be considered in weapon selection and time of attack planning. The result will be fewer weather aborts, improved effectiveness, reduced exposure to risk, and cost savings.

The program in atmospheric measurements and modeling for the Airborne Laser provides expanded understanding of atmospheric effects applicable to emerging HEL systems. High-altitude clouds (cirrus) and optical turbulence fundamentally limit ABL effectiveness and range. Early in the program, it was recognized that the variability of turbulence was producing variability in ABL performance. As a result, a parallel AFRL S&T program (with limited core S&T funding augmented by ABL funds) was initiated to examine atmospheric measurements and modeling. This effort has evolved into the Atmospheric Decision Aid (ADA) program.

From 1997-2000, the emphasis of the ADA program was on collecting theater turbulence data to validate ABL's design specification, which is based on data from core AFRL S&T work in the 1980s. Currently, the emphasis has shifted to modeling and forecasting. By merging the operational Air Force numerical weather model with an optical turbulence model, a 3-dimensional forecast of turbulence, including its temporal variability, is being developed. High-altitude clouds are another focus of the ADA model. More specifically, improved models of cirrus forecasting and the resulting laser transmission are required for ABL performance. AFRL is developing the models and software for delivery to the ABL's

ADA integrator contractor to be implemented into a system that can be fielded.

The initial goal of the ADA is to support the ABL test phase by optimizing orbit placement; this modest goal can be achieved using existing models. The more ambitious goal, however, is to quantitatively forecast performance in terms of maximum effective range or required dwell time. To achieve this goal requires a longer-term core lab S&T program to improve the current state-of-the-art of turbulence and cirrus modeling.

Emerging HEL laser systems for air-to-ground applications suffer far more performance variability than does the ABL in its missile defense mission. This is a result of the atmospheric boundary layer and the degree to which weather and diurnal cycle affect performance. In addition to turbulence, the full range of cloud fields and aerosols will need to be modeled in air-to-ground applications.

The first-order effect of clouds on EO and HEL systems has to do with line-of-sight to the target. This effect is quantified through the cloud-free line-of-sight (CFLOS) statistic. Although CFLOS is a basic concept, it is somewhat unique to military problems. Additionally, clouds vary significantly with season and location, and therefore a firm understanding of the climatology of CFLOS over militarily significant areas is needed. As future HEL systems are specified and designed, realistic physical models of clouds and CFLOS are required—particularly in light of the increased importance of virtual engineering, simulation, and testing. And as these systems are deployed, the ability to forecast clouds in terms of CFLOS probabilities will become essential. These capabilities will require an improvement in the current ability to forecast clouds, including improvements in satellite cloud sensing, using numerical weather models.

Although employment modes for some HEL systems may eliminate or minimize atmospheric effects (such as the Space-Based Laser or reduced distances-to-target for the ABL), it is desirable that these systems be effective in much more broadly defined scenarios, especially when adjunct missions are considered. Atmospheric modeling and decision aids will significantly enhance HEL systems and expand their operational capabilities, much like the demonstrated contribution of atmospheric decision aids to the effectiveness of comparatively simpler systems such as IR seekers. Like the ADA program for the ABL, expanded capabilities will need to be tailored to the operational scenarios and lethality mechanisms of new HEL systems. Advancements in atmospheric modeling and decision aids will require an expanded, long-term S&T program, as the need for atmospheric models is military-specific and is not being addressed by the civilian research community. Further, a tri-Service S&T program needs to coordinate the expertise resident across the Service laboratories, so that it is effectively focused on this difficult problem.

THE SURFACE ENVIRONMENT

Atmospheric propagation effects, and the thresholds at which these effects are significant, must be understood for the Army to employ laser weapons. In particular, knowledge of threat lethality coupled with knowledge of propagation of HEL beams from beam generators to targets is a critical requirement for the Army to proceed with development of HEL weapon systems. This understanding will, to a major extent, define the required laser weapon system.

Of primary concern to the Army are the effects of high turbulence and high aerosol scattering on the propagation of the HEL beam from the source to the target. The nonlinear effects also discussed below are of lesser concern, as thermal blooming is well understood and stimulated Raman and Brillouin scattering should not be important at the power levels planned by the Army.

Optical turbulence can cause the HEL beam to jitter on the target as well as decrease the energy density on target. The beam jitter arises from the temporally differing refractive index of the air over the HEL beam path. In principle these effects can be corrected using sophisticated sensors to measure the turbulence and adaptive optics to appropriately adjust the HEL beam profile. In practice, however, both the sensing and adjustment are difficult and are effective over a limited range of conditions. The Army must develop an understanding of atmospheric turbulence in battlefield environments and then characterize its effect on weapon system performance.

On the battlefield, aerosol scattering can affect the operation of laser weaponry. These aerosols arise from battlefield obscurants, airborne dust thrown up by exploding ordnance, and smoke from burning equipment destroyed in the battle. Also, natural aerosols including fog, precipitation, and clouds must be considered in any planned use of laser weapons. It is generally understood that the effects of aerosols will scale unfavorably as the laser wavelength shortens, while no differences are anticipated between pulsed and CW lasers.

Absorption by atmospheric gases and aerosols can generate atmospheric density gradients causing the laser beam to drop in aerial power density. This effect is known as thermal blooming. Airflow across the laser beam generated by either winds or slewing of the beam can mitigate thermal blooming. Other non-linear effects include air breakdown and stimulated light scattering, limiting the range of operating parameters of the laser. The values of parameters such as power or pulse energy, pulse rate, and pulse duration, at which these non-linear effects are

triggered, need to be established using existing models and then confirmed with experimental data in atmospheres of concern to the Army.

Stimulated light scattering includes stimulated Raman scattering (SRS), stimulated Brillouin scattering (SBS), and stimulated thermal Rayleigh scattering (STRS). Spontaneous scattering such as spontaneous Rayleigh or Raman scattering is not a function of input power or intensity; however, SBS and SRS have gains proportional to input intensity and can become cascading phenomena. This latter class of non-linear, stimulated phenomena can become catastrophic to high-energy laser propagation. Since SRS and SBS compete with one another, SBS can dominate over SRS except in the case of short radiation pulses of less than a few nanoseconds where the SBS process has insufficient time to establish itself. SRS results in a frequency shift of the scattered radiation in both the forward and backward directions. Since SBS has a zero frequency shift in the forward direction, it is only observed in backscattering. The scattered intensity can approach that of the laser, resulting in a depleted laser beam.

Linear and non-linear atmospheric effects can result in tracking and pointing errors, a reduction in on-target irradiance, and limited fluence on the target such that lethal effects may not be realized. Technical remedies for these problems are available and can, within reason, restore the desired performance. For example, adaptive optics may be employed to compensate for turbulence and thermal blooming effects, if the effects are not too significant. But adaptive optics systems are complex and not always sufficiently effective. Operational remedies are also available such as deploying more systems or changing the way systems are placed on the battlefield. A better understanding of atmospheric effects is needed in order to develop well-designed experiments and evaluate the potential effectiveness of particular lasers or laser wavelengths in various applications or environments.

CHALLENGES OF THE MARITIME ENVIRONMENT

There are several challenges related to atmospheric effects and propagation in developing a high-energy laser weapon system that will operate in a maritime environment, such as that depicted in Figure 50. The atmosphere just above the ocean is very different from the atmosphere over land, and will require selection of the appropriate wavelength, power level, pulse format, and beam control in order to deliver a lethal amount of energy to a target. Absorption and scattering are the primary causes for loss of energy in this environment.

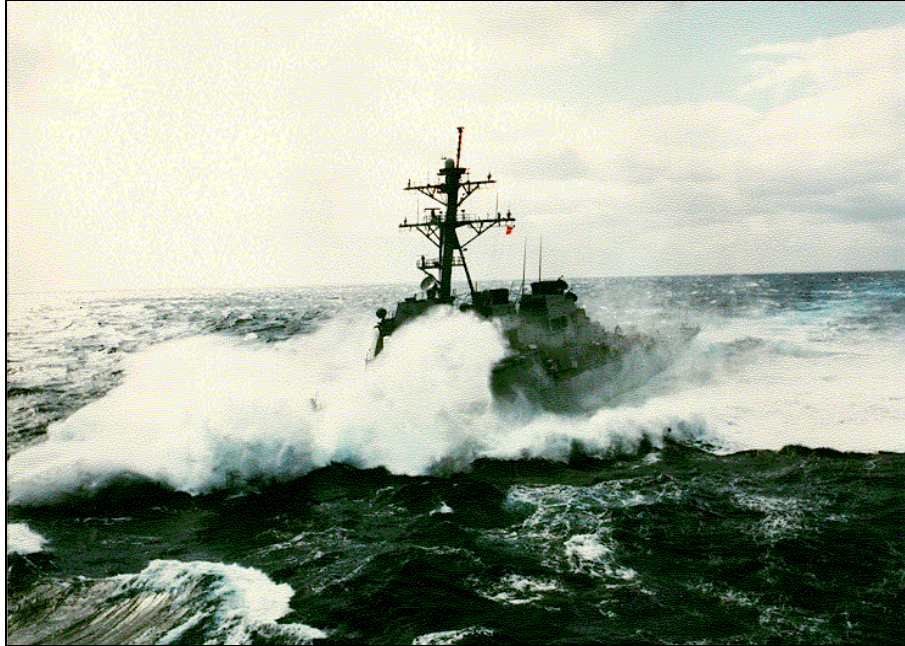

Figure 50. The Maritime Environment Presents Unique Challenges for HEL Weapon Systems

At low power levels the effects of these loss mechanisms are linear, meaning an increase in power from the laser results in an increase in power delivered at the target. As Figure 51 illustrates, the primary windows with low absorption in the maritime environment are located at about 1.0, 1.3, 1.6, and 2.2 microns. Of the four, the window at 1.0 micron has the lowest level of absorption. However, the amount of energy lost to scattering increases with decreasing wavelength, with the greatest scattering at 1.0 micron. The result is that the total loss through both absorption and scattering is about equal across the four windows. If these were the only losses, the 1.6 and 2.2 micron windows might be preferred since they both fall in the region of the spectrum considered “eye-safe,” whereas the 1.0 and 1.3 micron lasers are not considered to be “eye-safe.”

In contrast, absorption leads to non-linear losses for high-energy lasers. Specifically, an increase in power from the laser results in an increasing percentage of energy loss. This non-linear loss comes from thermal blooming, which in effect creates a negative lens in the atmosphere. The effects of thermal blooming are illustrated in Figure 52, which shows the intensity at the target with and without thermal blooming.

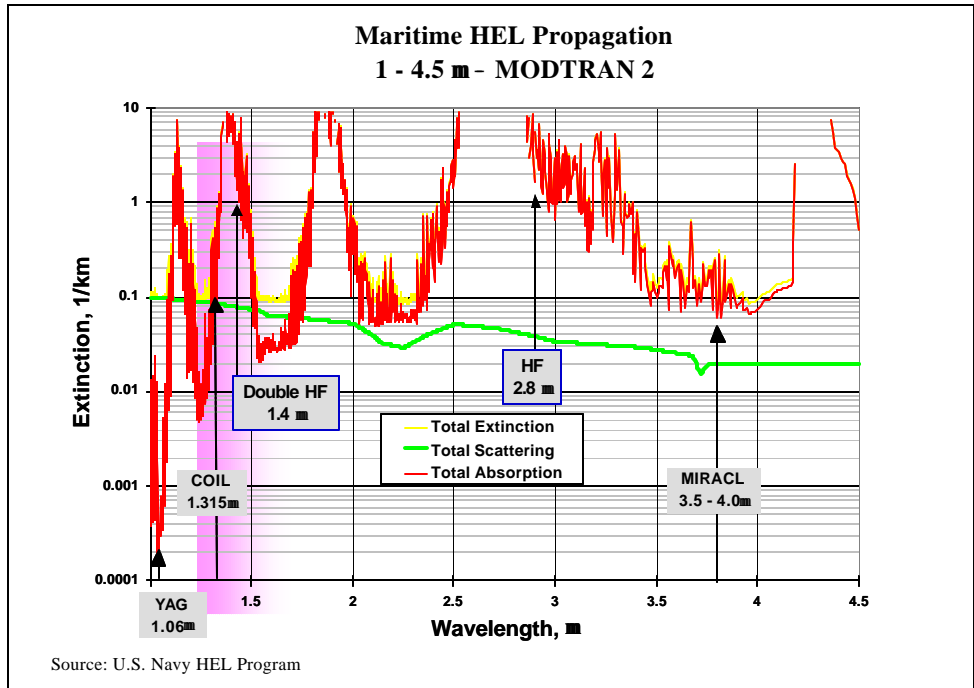

Figure 51. Absorption and Scattering Windows

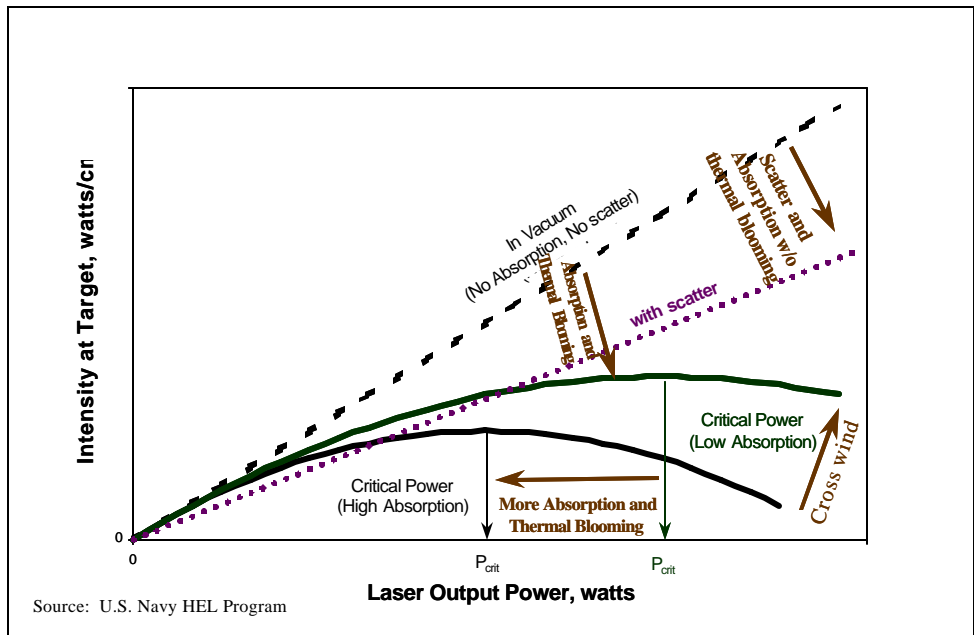

Figure 52. Effects of Thermal Blooming

The maximum amount of power that can be delivered from a laser without reducing the amount of energy on the target is known as the critical power level, P_{crit} . This is, in effect, an upper limit on power for that laser operating at a particular wavelength. When the effect of thermal blooming is taken into consideration, the use of a laser operating at 1.0 micron makes by far the most sense because its P_{crit} is much higher than those of the other three wavelengths. Some studies have indicated that the P_{crit} for the 1.0-micron wavelength is above 10 MW for distances out to a few kilometers, with only minimal relative wind. If the decision is made to operate a laser at multi-megawatt levels in the maritime environment, the low level of absorption at the 1.0-micron wavelength combined with its higher power on target may outweigh the concerns associated with the eye-safe issue.

Absorption and scattering data are generally incorporated in analysis using statistical averages. In reality, maritime conditions at a particular geographic location and at a particular time may favor different wavelengths on different days. This variable nature of maritime conditions, coupled with the thermal blooming problem, has led the Navy to consider the use of the free-electron laser. In addition to having the capability to make a free-electron laser mobile via shipboard installation, the ability to select different wavelengths with this device is a vital capability for a maritime laser.

As can be seen in the equation below, the wavelength of the laser beam, λ , can be controlled by changing one of three variables in the laser: the undulator period, λ_w ; the undulator parameter, K_w ; or the energy of the electron beam, γ .

$$\lambda = \lambda_w (1 + K_w^2) / 2 \gamma^2$$

This ability to select a wavelength over a wide range is not available with solid-state or chemical lasers. At the multi-megawatt level, the ability of a free-electron laser to tune across wavelengths will also be limited by the bandwidth of the mirrors used in the resonator design. However, even at high power levels, the free-electron laser could be pre-designed to operate at two or more different wavelengths. At a minimum it could be designed to operate at two wavelengths, one eye-safe and one tactical. This type of two-wavelength operation is already being used in other military laser systems such as the Advanced Targeting Forward Looking Infrared devices being installed on F-18 aircraft. For a high power FEL, multiple-wavelength operation would most likely require changing the optical cavity mirrors when changing modes of operation. Such a capability could be designed into the system and require only push-button control by an operator.

In addition to the atmospheric physics involved with the deterioration of a high-energy beam, there are significant engineering challenges involved in installing any system onboard a Navy ship or submarine. Almost all of the topside equipment on a Navy ship will be wet at some time, and developing a laser system that can operate with a wet beam director may be required to field a weapon system. These are typical naval system engineering problems and would be addressed once the appropriate laser source was determined.

TASK FORCE FINDINGS

1. Renewed interest in tactical HEL applications (such as mobile THEL, the ATL, and maritime self-defense) requires expanded efforts to measure and understand low-altitude, “thick-air” atmospheric effects.
2. Primary concerns include the effects of atmospheric turbulence and aerosol scattering on the HEL beam. Non-linear propagation effects such as thermal blooming can also have important effects for many applications.
3. Technical remedies are available to deal with atmospheric turbulence, but much more understanding is needed, as is the ability to predict and measure atmospheric turbulence.
4. Non-linear propagation effects require detailed analyses and experiments. They also require beam control concepts to ameliorate the negative effects. No such analyses or experiments exist for multi-pulse systems.

UNDERSTANDING EFFECTS AND VULNERABILITY

With the expansion of “effects-based operations” in U.S. military planning and operations, there is a high demand for precise understanding of the range of effects of directed-energy weapons. Yet today, there is limited understanding of directed-energy effects and the vulnerability of U.S. systems. While a number of experiments have been conducted, there is an urgent need to analytically and systematically understand directed-energy effects in order to employ them appropriately and effectively.

Directed-energy effects are highly dependent on the composition of the target, the fluence level on the target, the angle of incidence, laser wavelength, the target’s environment, and other factors. Just as in the case

of kinetic-energy weapons, no database will ever be complete or totally predictive; however, there are some important questions in the fundamental understanding of these effects. There is, after 30 years, uncertainty over the effect of the pulsed laser relative to the CW laser. There is also uncertainty about very short-pulse laser effects. Most pulse laser tests have been two-dimensional due to limited spot size; hence the roles of surface-created plasma, pulse energy, pulse length, the target environment, and even the target material are not well understood.





Coupon-level testing, subscale testing, and some selective full-scale testing are needed to fill in existing databases and create a modeling and simulation capability to develop realistic probabilities of kill (Pk) to determine both the characteristics required for directed-energy weapon systems as well as vulnerability and potential hardening of U.S. assets.

THE CURRENT PROCESS

There is a long-standing and well-established process for developing and presenting explosive weapon effects for the Department of Defense. This process resides in the Joint Technical Coordinating Group for Munitions Effectiveness. This group produces the Joint Munitions Effectiveness Manual (JMEM). The JMEM grew from the need for explosive weapon phenomena and effects data that was brought about by the system and operational analysis process instituted by the Department of Defense in the mid 1960s. The charter, mission, history, organization, process, and other information about the Joint Technical Coordinating Group for Munitions Effectiveness and its products are shown in the following set of figures.



Figure 53. Joint Technical Coordinating Group for Munitions Effectiveness

<p>JTCG/ME CHARTER</p> <p>DEPARTMENT OF THE ARMY HQ US ARMY MATERIEL COMMAND WASHINGTON DC 20315</p> <p>DEPARTMENT OF THE NAVY HQ NAVAL MATERIEL COMMAND WASHINGTON, DC 20300</p> <p>DEPARTMENT OF THE AIR FORCE HQ AIR FORCE LOGISTICS COMMAND WRIGHT-PATTERSON AFB, OHIO 45433</p> <p>DEPARTMENT OF THE AIR FORCE HQ AIR FORCE SYSTEMS COMMAND ANDREWS AFB, WASHINGTON, DC 20330</p> <p>CHARTER FOR JOINT AMC/NMC/AFLC/AFSC COMMANDERS JTCG/ME</p> <p>DATE: 10 Dec 1968</p>	<p>Prepare and Publish Joint Munitions Effectiveness Manuals(JMEMs) for Fielded Systems</p> 	<p>Develop, Maintain and Update Databases</p> <ul style="list-style-type: none"> • Weapon Effectiveness • Weapon Characteristics • Delivery Accuracy • Reliability • Vulnerability 
<p>Standardize Methodologies</p> 	<p>Conduct Special Studies/Activities</p> <ul style="list-style-type: none"> • Joint Live Fire (JLF) • Data Collection Efforts from Operational Employment • JMEM Seminars 	

Joint Service Authenticated Products

Joint Munitions Effectiveness

Figure 54. Charter and Mission

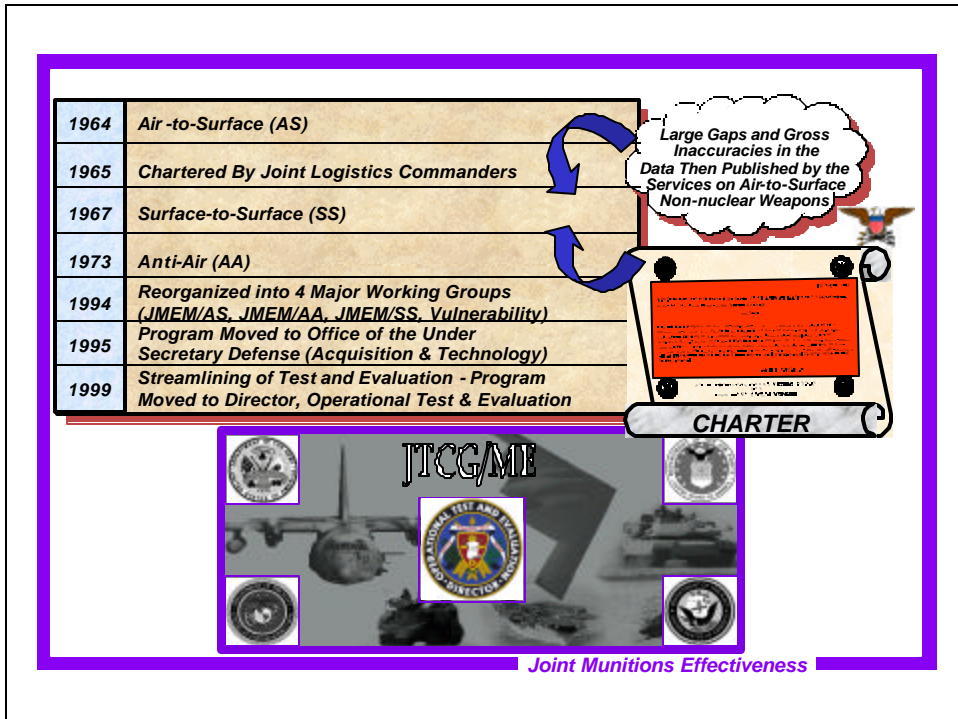

Figure 55. History

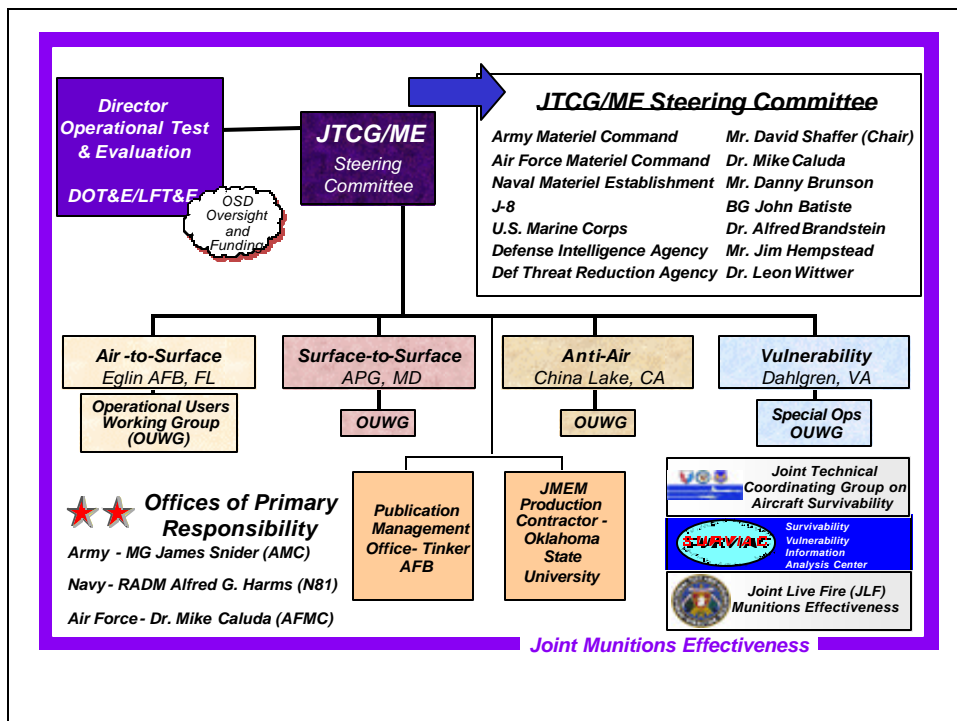

Figure 56. Organization

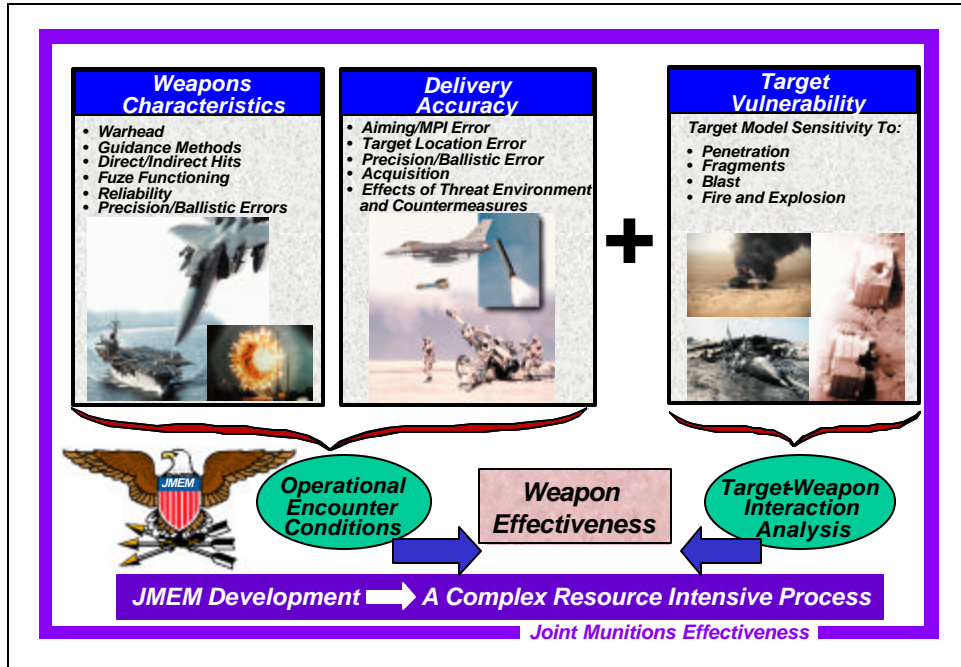

Figure 57. JMEM Weapons Effects Process

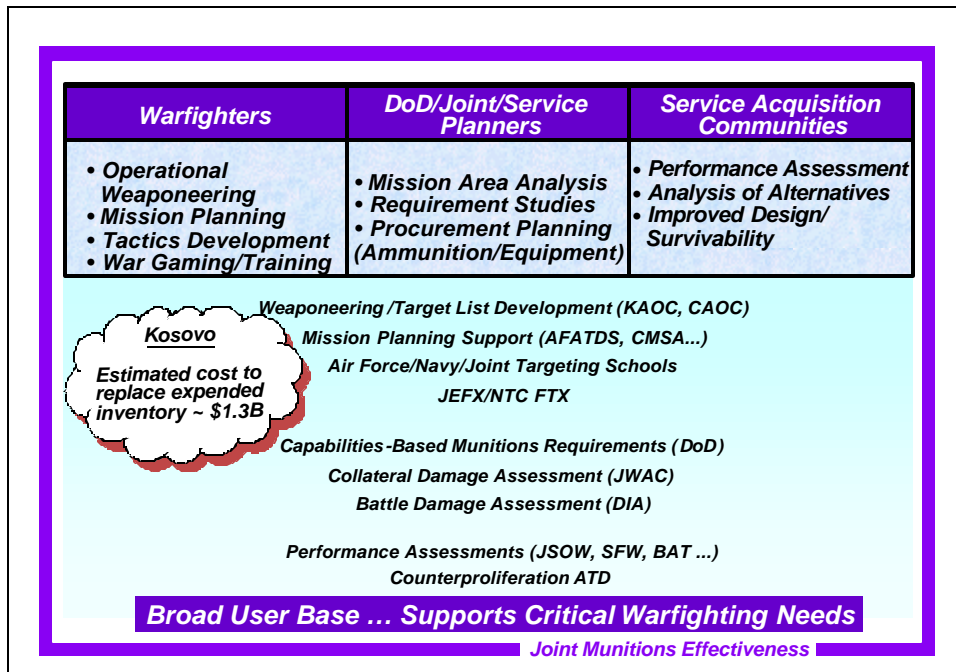

Figure 58. JMEM Users

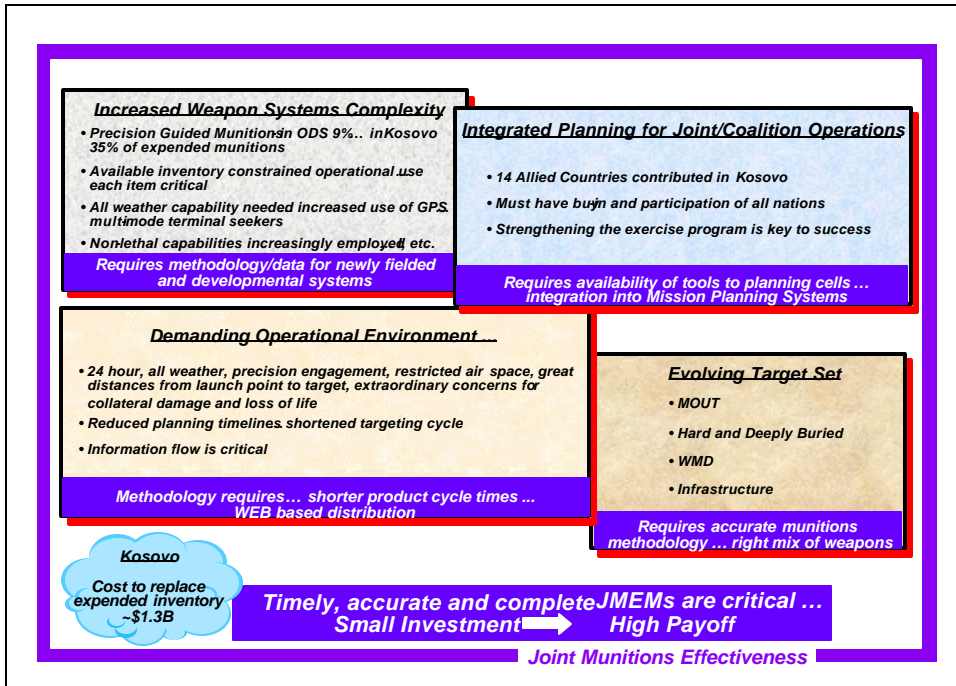

Figure 59. JMEM Responsive to Changing Warfare Environment

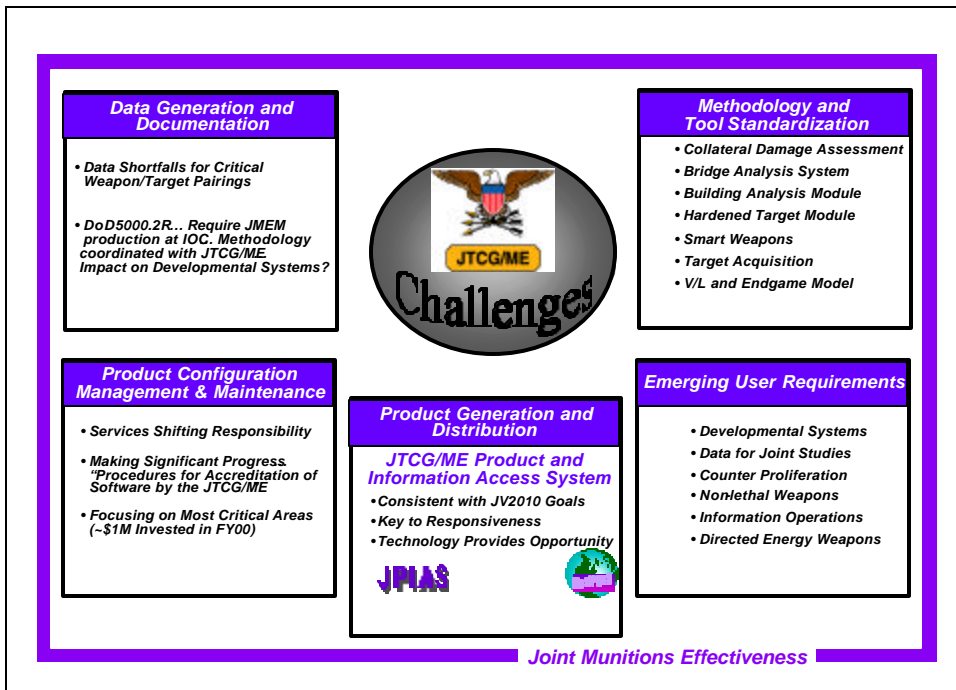

Figure 60. JTCG/ME New Program Challenges

REQUIRED WORK

The Department of Defense needs to develop, coordinate, and publish effects- and vulnerability-related materials for directed energy weapons:

- Define effects-producing mechanisms of directed-energy and information weapons.
- Determine target and component vulnerability.
- Develop an effectiveness methodology (common measures of effectiveness) to permit understanding of the effects relationships with standard conventional weapons.
- Develop (or oversee development of) and provide target and effects models along with associated tools to aid predictive planning, weapon employment decisions, and effects assessment of directed-energy and information weapons.

TASK FORCE FINDINGS

1. Only limited relevant data exist on directed-energy weapons effects. While a large number of experiments have been conducted, there is an urgent need for a systematically obtained, archived, and understood set of directed-energy effects on targets of military significance. The equivalent of the Joint Munitions Effectiveness Manual for kinetic-energy weapons is needed.

MODELING AND SIMULATION

The problem of designing and fielding effective high-energy lasers is a difficult mixture of physics, engineering, and operational issues. Multiple levels of models and simulations are needed to adequately address the issues, including physics models of basic processes, system engineering tools, system performance models, and effectiveness models.

PHYSICS MODELS

General theoretical treatment of the physical phenomena inherent in the interaction of laser beams with both the environment and the target are, for the most part, adequate. However, these models do not adequately address all processes—such as propagation and lethality, for example.

Propagation

In the area of propagation, there are wave optics codes that represent the physics of the problem. There are atmospheric data to describe “point design” atmospheres. There are experimental data on the effects of a specific atmosphere on the propagation of a high-energy laser beam with and without adaptive optics. But it is rare to be able to measure the specific atmosphere in the experiment well enough to match the one in the simulation. Moreover, existing simulations cannot be run enough to cover all of the needed variants.

There is not sufficient definitive information to properly characterize the distribution of atmospheres (including artificial components) that could be faced in the battlespace. As a result, it is difficult to settle debates over how much margin in transmitted beam energy is enough to negate threats of interest. Experimental data on atmospheres of interest to the range of operations are needed.

Lethality

On the matter of lethality, the current process seems to be able to work any problem *a posteriori*. That is, one can choose the lethality mechanism, obtain or construct samples of the material(s) in the target of interest, run small scale tests to determine the values of the parameters used in the lethality model, and calculate the lethality of a particular, postulated HEL beam against that target.

It is difficult, however, to validate the lethality process because it is difficult to conduct full-scale tests under conditions in which measurements of reasonable fidelity can be made. In addition, the first principle codes that allow exploration of different lethality mechanisms *a priori* do not exist.

There are a number of propagation models available, but most are difficult and cumbersome to use in real programs. There is a large lethality community with extensive databases and a large set of predictive techniques. Almost any request for lethality information is answered with the need to first run a test. A carefully crafted set of key experiments must be conducted to anchor performance models over the parameter space of interest.

SYSTEM ENGINEERING TOOLS

The process of designing a high-energy laser system involves trade-offs over a large number of subsystem issues in order to reasonably optimize the expected performance of the resulting weapon system. Currently the set of systems engineering tools are not well integrated to

the extent that overall system level trades can be smoothly executed. Subsystem models, of the laser subsystem for example, usually exist. But these subsystem models are not completely validated in some cases or must be anchored in experiments that limit the range of the trade space. As a result, predicting final system parameters in the early design phase is more of an art form than an engineering science. Thus, early confidence in ultimate performance and design margins is low.

SYSTEM PERFORMANCE MODELS

Each program office should construct a model of the intended system with sufficient fidelity to evaluate expected system performance and to provide the underpinning for effectiveness analyses. These models should handle one-on-one and one-on-many engagements in detailed representations of the expected battlefield environment. In those cases where operator functions significantly affect systems performance, a version of the system model must be coupled with a man-in-the-loop simulator.

EFFECTIVENESS MODELS

Effectiveness models are used to determine the “military utility” or value added of augmenting the force with new technologies, systems, and concepts. These models are usually general-purpose combat models augmented with representations of HEL systems. To assess HEL weapons, key input on anticipated performance parameters is obtained from the developers, hopefully based on systems models. These performance variables include lethality values as a function of target type, range, required “time on target,” and other variables dependent on the lethality mechanism. Additional performance variables include target acquisition time, retargeting time, kill assessment, and anticipated cycle time or magazine depth.

Using effectiveness models, the system characteristics, force structure, and concepts of operation will be modeled within the force-on-force simulation as part of a combined arms force executing an operational mission. The military utility of the HEL weapon will be measured in operational metrics linked to battle outcome. Typical metrics used to indicate military utility of an HEL weapon would be an increase in Blue survivability or an increase in Blue lethality corresponding to increased survivability. The results can be used to refine the concept of operations as well the force structure. When assessing emerging technologies or a new implementation of a current technology, many of the performance

parameters are uncertain. In this situation, a parametric analysis can be used to set upper and lower limits on anticipated performance. The corresponding results can then be used as the basis for system requirements.

When significantly different types of weapon systems are being considered for deployment, man-in-the-loop simulators need to be used in conjunction with combat models to develop system level technology transition plans (ITPs). This approach will also provide the basis for training simulators for deployed systems. In a similar manner, the use of interactive (gamer-controlled) combat simulations allows flexible examination of unit-level tactics.

TASK FORCE FINDINGS

1. Much of the characterization of the interaction of an HEL beam with targets of military significance has been validated over only a limited range. These predictive methods are empirically based, with general theoretical treatments anchored by limited experimental testing. Detailed treatment of the underlying physics is necessary.
2. There is insufficient validation of lethality mechanisms under conditions in which measurements of reasonable fidelity can be made.
3. There is insufficient definitive information to properly characterize the atmospheres within a battlespace, at least to the extent needed to provide a predictive capability.
4. There is insufficient effort being directed at modeling the entire optical train for any system, starting from an HEL resonator and proceeding through the beam control system and exit aperture to the target.

BEAM CONTROL

A recent study by the High Energy Laser Executive Review Panel Beam Control Working Group has provided considerable insight into the issue of beam control, with implication for all HEL systems. This section summarizes the key conclusions of the working group's efforts.

Beam control consists of all functions that need to be performed to deliver a high-energy laser beam from the laser device to the target, as illustrated in Figure 61. It incorporates many components needed to perform these functions. Figure 62 lists examples of these functions and corresponding components.

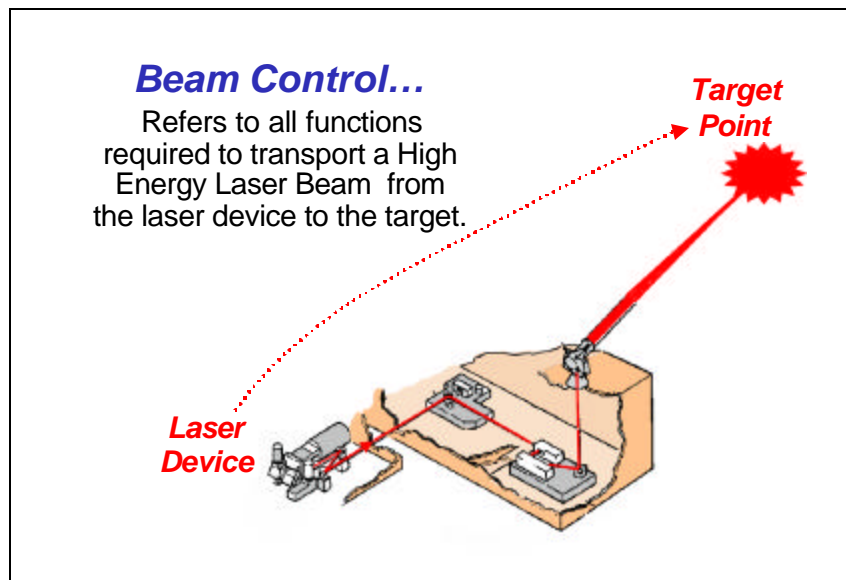

Figure 61. Beam Control

The specific requirements and particular design of a beam control system depend critically on two factors: the specific implementation concept and the specific application being addressed. These factors can influence a beam control system and therefore the requirements needed for technology development, as described in Figure 63.

The Beam Control Working Group defined a set of representative concepts and applications, including several development generations, on which to focus their review. These concepts, shown in Figure 64, became the basis for formulating technology assessments and investment strategies.

Functions	Components
Beam Path Conditioning	Aperture Sharing Elements
HEL Beam Cleanup	Fast Beam Steering Mirrors
Beam Alignment, Positioning and Management	High Reflectivity Mirrors
Atmospheric compensation for turbulence and/or thermal blooming	Deformable Mirrors/Compensating Elements
Target Acquisition	Windows
Beam Pointing and Maintenance	Large optics
Active/Passive Precision Tracking	Illuminators
Beam Expanders and Projectors	Coatings
Beam Relay Optics Systems	Wavefront Sensors
Health and Status monitoring	High Speed Computational Capability

Figure 62. Beam Control Definitions

Many beam control **Components** and most beam control **Functions** are common to any HEL system, but...

<p>...specific concepts drive <i>unique beam control technology requirements</i></p> <ul style="list-style-type: none"> • Pulsed versus CW systems • Single versus Multiple Wavelengths • Single versus Multiple Devices • Terrestrial versus Extra -terrestrial • Maintainability and Servicing Availability • Propagation distance and Atmospheric Path • Power level 	<p>...specific applications drive <i>unique beam control technology requirements</i></p> <ul style="list-style-type: none"> • Ground Based Lasers • Airborne Laser • Space Based Laser • Tactical High Energy Laser • <i>Airborne Tactical Laser</i> • <i>Relay Mirror</i>
---	---

Figure 63. Beam Control Requirements Strongly Define Technology Investments

	1st Generation	2nd Generation	3rd Generation
Airborne Laser	ABL PDRR	ABL EMD	Adv ABL
Space Based Laser	IFX	SBL(PDRR)	Adv SBL
Ground Tactical Laser	THEL	Mobile THEL	Compact THEL
<i>Ground Based Lasers</i>	GBL/ASAT	GBL/Relay Mirrors	
<i>Airborne Tactical Laser</i>	ATL	HEL Tactical Fighter	FotoFighter
<i>Relay Mirrors</i>	Low Power/LASSOS	High Power RME	Multi -mission RM

Figure 64. HEL System Development Concepts

The panel updated its technology assessment for a number of the original concept classes, with specific attention to the current generation programs. Though the working group conducted a more thorough review, Figure 65 summarizes its top-level assessments.

Current Generation Concepts				
	GBL/SOR	ABL/PDRR	SBL/IFX	TacHEL/ATL
Beam Control Elements				
Wavefront Control				
ATP				
Beam Transfer and Alignment				
Beam Director/Turret Assembly				
Integration				

Legend

- Lowest Risk*
- Medium Risk*
- Highest Risk*

*... of being a limiting technology to performance

Figure 65. Beam Control Assessment

FINDINGS OF THE BEAM CONTROL WORKING GROUP

The following two sections summarize the findings and recommendations of the Beam Control Working Group, which point to the need for considerable technology investment in this area—investment that will benefit many of the HEL programs in development today.

1. Today we need a balanced investment strategy that addresses the full spectrum of the required beam control development activities needed for first- through third-generation HEL systems appropriate for potential applications and system implementation concepts.
 - A unified planning and management structure that is responsible for beam control technology developments for all mission areas and applications is needed.
 - Beam control technology and functions cut across applications, lasers, platforms, and missions.
 - Current coordination through the reliance process (Technology Integration Planning for Directed Energy Weapons [TPDEW]) avoids duplication but does not provide a centralized management (planning) function.
2. Demonstration systems under way today (first-generation) are based on the substantial beam control investments of the mid to late 1980s.
 - Every system has identified specific shortfalls (many of which are common) that have not been met by these earlier investments either through neglect or surprise.
 - Basic beam control concepts and implementation approaches for today's programs came from approaches developed in the 1970s.
3. Beam control component technology development has been seriously neglected for the last 8-10 years.
 - Technology for second- and third-generation systems is seriously lacking.
 - First-generation integrated demonstration programs will not produce advanced beam control technology for follow-on generation systems.
4. Integration (subsystem and system level) is a major beam control technology issue.
 - Historically, investments in integration beam control demonstrations have been much greater than component investments.

- Many integration/demonstration efforts occurred from 1985 to 1991.
 - The few ongoing advanced technology integration programs (maturing technology for second-generation systems) are significantly underfunded or nonexistent.
 - Essentially no advanced technology integration programs are currently underway, or planned, for third-generation systems.
5. The industrial base for critical beam control technologies is extremely thin, with many technologies available from only one or two sources.
 - This deficiency applies to developing and manufacturing beam control components such as deformable mirrors, windows, coatings, aperture-sharing elements, fast-steering mirrors, wavefront sensors, detectors, and processors.
 - Many vendors are preoccupied financially with commercial interests.
 - The pool of individuals with expertise in beam control technologies and system integration is critically low and still declining.
 6. Facilities for characterization and testing of beam control components are either nonexistent or suffering from neglect.
 - Industry strongly agrees with the need for this capability to support beam control developments.
 - Industry supports a government function in this area.
 7. Shrinking budgets have compromised adequate documentation of many beam control activities.
 - Lessons learned, key data, and other critical information from past programs have been lost.
 - The problem is exacerbated by the “brain drain” and aging-work - force departures.
 - Industry strongly supports a government role in archiving this information for use by future programs.
 8. There appears to be no appreciable work on beam control for multi-pulsed high-energy lasers for at least 20 years.
 - Beam control approaches and requirements for pulsed and multi-pulsed laser systems are potentially very different.
 - There are advantages and disadvantages to each approach.

BEAM CONTROL WORKING GROUP RECOMMENDATIONS

1. Rebalance the S&T investment strategy with 1/3 of the HEL S&T funding directed to component and concept development. This will provide the tech-base required for our next-generation HEL systems.
2. Implement a structure for managing beam control technology developments for HEL systems to provide a focal point for concept exploration and concept effectiveness evaluations, technology maturity and risk assessments, and planning, budgeting, and coordinating development activities.
3. Invest in independent, government-operated beam control component characterization facilities supporting all directed-energy weapon mission areas.
4. Maintain standard HEL modeling and simulation tools in beam control technology and system modeling through a government documentation and tracking process.
5. Establish an initiative to increase or improve science and engineering labor pool.

FUTURE INVESTMENT STRATEGY

To begin to address its findings and recommendations, the Beam Control Working Group created a prioritized strategy for technology development, shown in Figure 66. Figure 67 shows a funding proposal that would meet the shortfalls of current and future program needs.

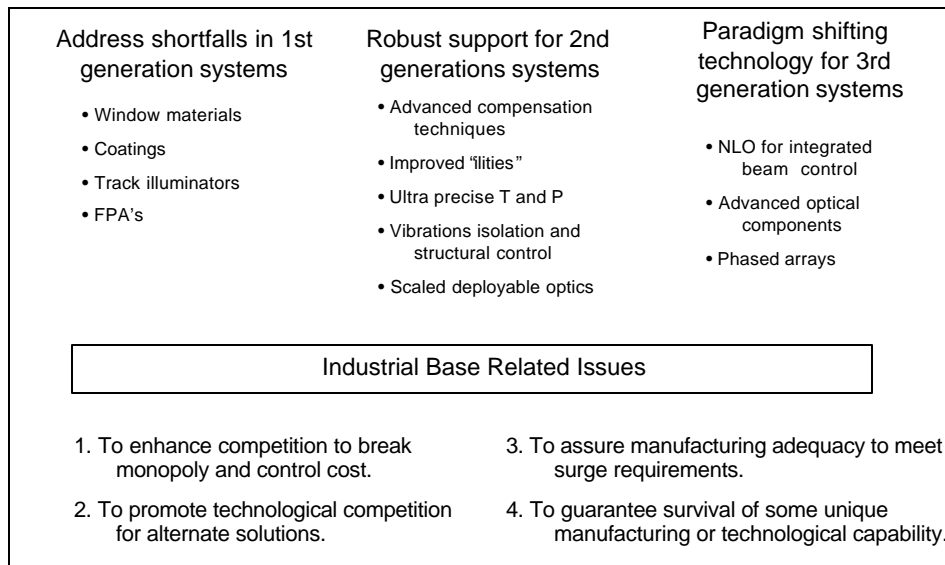

Figure 66. Strategy to Address Findings

Figure VI-1. Appropriate Beam Control Funding Levels

Categories	2002	2003	2004	2005	2006	2007	TOTAL
COMPONENTS & ELEMENTS	55,000	57,200	59,488	58,212	53,813	53,609	337,223
LARGE / DEPLOYABLE OPTICS	15,000	15,600	16,224	16,873	17,548	18,200	
LASER WINDOWS	2,000	2,080	2,163	2,250	2,340	2,433	
BEAM PATH CONDITIONING	0,500	0,520	0,541	0,562	0,585	0,608	
COATINGS	1,500	1,560	1,622	1,687	1,755	1,825	
APERTURE SHARING ELEMENTS	1,500	1,560	1,622	1,687	1,755	1,825	
FAST STEERING MIRRORS	0,500	0,520	0,541	0,562	0,585	0,608	
STABLE PLATFORMS (IR/US)	4,000	4,160	4,326	4,444	4,585	4,733	
UNCONVENTIONAL WAVEFRONT CC	2,000	2,080	2,163	2,250	2,340	2,433	
WAVEFRONT SENSORS	1,000	1,040	1,082	1,125	1,170	1,217	
VISIBLE FOCAL PLANE ARRAYS	0,500	0,520	0,541	0,562	0,585	0,608	
IR FOCAL PLANE ARRAYS	2,000	2,080	2,163	2,250	2,340	2,433	
ACTIVE TRACKING LASER	12,500	13,000	13,520	14,061	14,619	15,199	
BEACON LASERS	6,000	6,240	6,490	6,749	7,019	7,300	
CONVENTIONAL DEFORMABLE MIRS	1,500	1,560	1,622	1,687	1,755	1,825	
NEW TECHNOLOGY DEFORMABLE MIRS	2,500	2,600	2,704	2,812	2,925	3,042	
DEFORMABLE SECONDARIES	0,500	0,520	0,541	0,562	0,585	0,608	
PROCESSOR & ALGORITHMS	1,000	1,040	1,082	1,125	1,170	1,217	
DEVELOPMENTAL & INTEGRATED TESTS	29,000	30,160	31,366	32,621	33,926	35,283	192,356
SOR (AFRL)	12,000	12,480	12,979	13,498	14,038	14,600	
ACL (MILL)	2,000	2,080	2,163	2,250	2,340	2,433	
ATP-FC (AFRL/ROME)	2,000	2,080	2,163	2,250	2,340	2,433	
NOP (AFRL @ WSMR)	8,000	8,320	8,663	8,999	9,359	9,733	
OTHER (MMJL, SBL, ATL, PULSED BC)	5,000	5,200	5,408	5,624	5,849	6,083	
MODELING AND SIMULATION	6,000	6,240	6,490	6,749	7,019	7,300	39,798
STANDARDIZED WAVE OPTICS CODES							
SUBSYSTEM PHYSICS MODELS							
SYSTEM PERFORMANCE ANALYSIS							
EDUCATION/GRANTS, ETC.	6,000	6,600	7,260	7,986	8,785	9,663	46,294
ESTABLISH BC INSTITUTE - 1 OR 2	0,500	0,550	0,605	0,666	0,732	0,805	
ESTABLISH SCHOLARSHIP FUND	0,500	0,550	0,605	0,666	0,732	0,805	
GRANTS FOR FUNDAMENTAL RESEARCH	1,000	1,100	1,210	1,331	1,464	1,611	
BC MURI	4,000	4,400	4,840	5,324	5,856	6,442	
STUDIES AND ANALYSIS	5,000	5,150	5,305	5,464	5,628	5,796	32,342
HEL AAS							
ADV BC CONCEPT/APPLICATION STUDIES							
ML EFFECTIVENESS ASSESSMENT							
LARGE SCALE DEMONSTRATIONS (ACT)	100,000	103,000	106,090	109,273	112,551	115,927	646,841
SBL IFX							
THEL							
ATL							
GBL/RELAY							
ADVANCED ABL							
MAINTAIN CRITICAL INFRASTRUCTURE	8,500	8,755	9,018	9,288	9,567	9,854	
OCEL	1,000	1,030	1,061	1,093	1,126	1,159	
CHINA LAKE OCDC FACILITY	1,000	1,030	1,061	1,093	1,126	1,159	
ANOR	1,000	1,030	1,061	1,093	1,126	1,159	
HELSTF (WSMR)	4,000	4,120	4,244	4,371	4,502	4,637	
UDRI (AFRL/ML)	1,000	1,030	1,061	1,093	1,126	1,159	
INFRASTRUCTURE STUDY (DOE, DC)	0,500	0,515	0,530	0,546	0,563	0,580	
GRAND TOTAL	209,500	217,105	225,016	229,592	231,288	237,333	1,349,635

Figure 67. Proposed Funding Profile

TASK FORCE FINDINGS

1. A balanced investment strategy is needed that addresses the full spectrum of required beam control development activities for first-through third-generation HEL systems and for potential applications and system implementation concepts.
 - Beam control technology and functions cut across applications, lasers, platforms, and missions.
 - Current coordination of ongoing programs avoids duplication but does not provide a centralized management (planning)

function responsible for beam control technology developments for all mission areas and applications.

2. Beam control component technology development has been seriously neglected for the last 8-10 years.
 - Technology for second- and third-generation systems is seriously lacking.
 - First-generation integrated demonstration programs will not produce advanced beam control technology for follow-on generation systems.
3. Integration (subsystem and system level) is a major issue in the development of beam control technology.
 - The few ongoing advanced technology integration programs (maturing technology for second-generation systems) are significantly underfunded.
 - No advanced technology integration programs are currently underway or planned for third-generation systems.

LASER DEVELOPMENT

Advancement in laser technology is needed to realize a number of potential applications for high-energy laser systems. Areas where improvements are needed include increases in power and reduction in size, the latter being particularly important for tactical applications. The electrically energized solid-state heat-capacity laser (SSHCL) has the potential to provide a lethal laser weapon capability with a more compact size than current laser systems. This smaller size will enable mounting on ground combat vehicles and on tactical airborne platforms currently being contemplated for a number of applications discussed earlier in this report.

SOLID-STATE LASER

To move forward in developing the solid-state heat-capacity laser, the Army is considering a five-year demonstration program culminating in mid-FY 2006 with demonstration of a 100 KW (average power) SSHCL mounted on a Hybrid Electric High Mobility Multi-Purpose Wheeled Vehicle (HE-HMMWV).

The 100 KW demonstrator constitutes a demanding system integration effort that will allow credible extrapolation to laser weapon system

concepts ranging from 50 to 300+ KW. Such electric lasers could fulfill a variety of roles in future ground defense missions. The set of potential targets for the SSHCL could include ATGMs, EAAD targets, and short-range rockets. The demonstrator would be designed to protect against such threats within a range of ~2 km. Lower or higher average powers would reduce or extend the lethal range. Figure 68 shows the demonstrator concept and point design data.

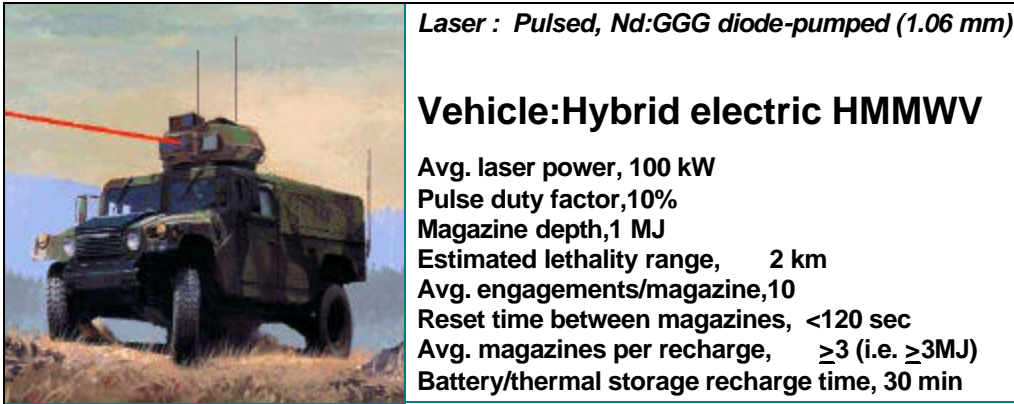

Figure 68. SSHCL 100 kW Demonstrator Concept

The laser system is a diode-pumped solid-state laser based on the heat capacity principle originally developed by Lawrence Livermore National Laboratory. This principle enables a defined period of laser operation, either sustained or individual shots, during which time heat from non-radiation transitions and other effects is stored in the neodymium-doped gadolinium gallium garnet (GGG) amplifiers. After the firing period, the laser is quickly cooled and firing can recommence. The aggregate output optical energy for the firing period is the “magazine depth” and the cooling period is the “reset time.” After several magazines, the system battery is recharged during the “recharge time.”

The HE-HMMWV is an excellent demonstrator mobility platform in several respects. Its power supply can be used as the source of weapon electric power. The vehicle has already been developed and demonstrated by the U.S. Army Tank and Automotive Command. Also, it presents a representative system integration challenge for mounting a high-power laser weapon.

The need for compact, low-weight protective weapons is driven by the Army’s desire for rapid deployment of ground forces to conflict areas anywhere on the globe. Thus, the Army has adopted a requirement that FCS weapon systems be transportable on a C-130 and essentially roll off in a battle-ready condition as conceptually illustrated in Figure 69. This requires that the vehicle and weapon together weigh less than 20,000 kilograms with a maximum height of less than 2.6 meters. The selection

of the HE-HMMWV as the demonstration mobility platform imposes a more severe constraint, because the suspension system limits the total vehicle plus weapon weight to below 5,500 kilograms.



Figure 69. Rendition of SSHCL Demonstrator Rolling off a C-130

The Army conducted a brief study to evaluate the feasibility of mounting a 100 KW SSHCL on an HE-HMMWV. This study provided insights into the scaling of weapon system volume and weight with average laser power. In addition to average laser power, magazine depth and battery and thermal storage recharge time are the critical subsystems affecting the system size and weight. These factors directly determine the design of the power supply and thermal management system.

A 3-D computer-aided design (CAD) model was created for the SSHCL on an HE-HMMWV as shown in Figure 70. The model begins with a bare, unsheltered HE-HMMWV with payload space and weight limits of $\sim 7 \text{ m}^3$ and $\sim 2,500 \text{ kg}$, respectively. With upgraded suspension, the weight limit can be increased to $\sim 3,200 \text{ kg}$. The simplified model attempts to correctly represent the volume displacement of the subsystems, so the lack of detail should not affect the conclusions. As Figure 69 illustrates, all major subsystems fit within the HE-HMMWV space envelope with a reasonable margin.

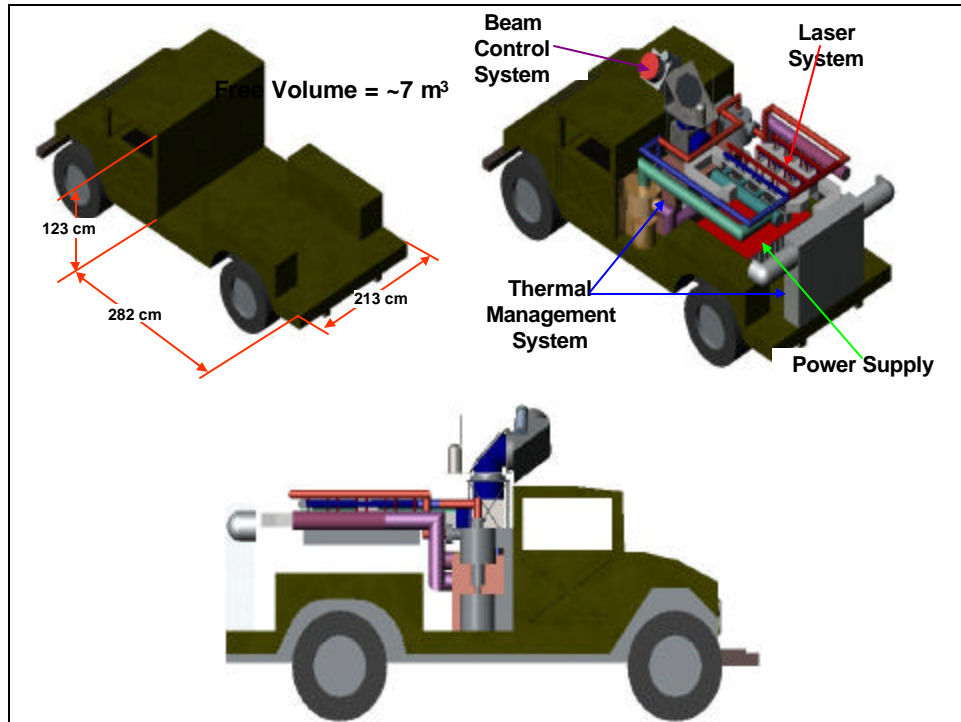

Figure 70. 3-D CAD Layout Study Showing Adequate Space for 100 kW SSHCL

The system weight study presented a more serious challenge than the layout study. Several design alternatives were examined, especially with respect to the power supply and thermal management system. The power supply is a battery-based system charged by the onboard diesel generator. Because the pulsed laser has a 10% duty factor and a ~10% power efficiency, a 100 KW average power SSHCL requires a peak electric power of ~10 MW with a pulse width of 0.5 msec (200 Hz rep-rate). The weapon energy requirement is ~65 MJ for three magazines.

The specific power and energy for selected commercial and developmental batteries is shown in Table 2. The table indicates that Pb-acid batteries are available in either high-energy (HE) or high-power (HP) versions, but both capabilities are not available in the same battery. Unfortunately, the SSHCL is demanding in both respects. This would lead to a very heavy two-stage battery if the selection criteria were limited to commercial technologies. Fortunately, active development activities are underway in battery technologies that offer both high specific power and high energy within the same battery. A good example is the lithium ion (LiIon) battery being developed by SAFT America. Very-high power (VHP) prototype units have demonstrated >10 KW/kg and 215 kJ/kg with very low internal impedance. Projected thin-film ultra-high power (UHP) concepts are projected at >20 kW/kg and 215 kJ/kg. A conceptual power

supply circuit which uses combined battery and capacitance effects for direct drive of the laser diode pump arrays with controlled switching with IGBTs is shown in Figure 71.

Table 3 gives total weapon system weight estimates for both LiIon VHP and UHP power supply systems. The table shows that an SSHCL weapon system based on prototype LiIon VHP batteries has an estimated weight consistent with the HE-HMMWV payload allowance with an upgraded suspension. An investment in LiIon UHP battery development will enable the SSHCL to meet an HE-HMMWV payload allowance with a standard suspension with margin.

Table 2. Weight Properties of Selected Battery Technologies

Battery Type	Specific Power (kW/kg)	Specific Energy (kJ/kg)	Technical Readiness
Pb-Acid (HE)	0.3 – 0.4	90 - 125	Commercial
Pb-Acid (HP)	5 - 8	~35	Commercial
Lithium Ion (VHP)	>10	~215	Prototype Data
Lithium Ion (UHP)	>20	~215	3-5 yr Development

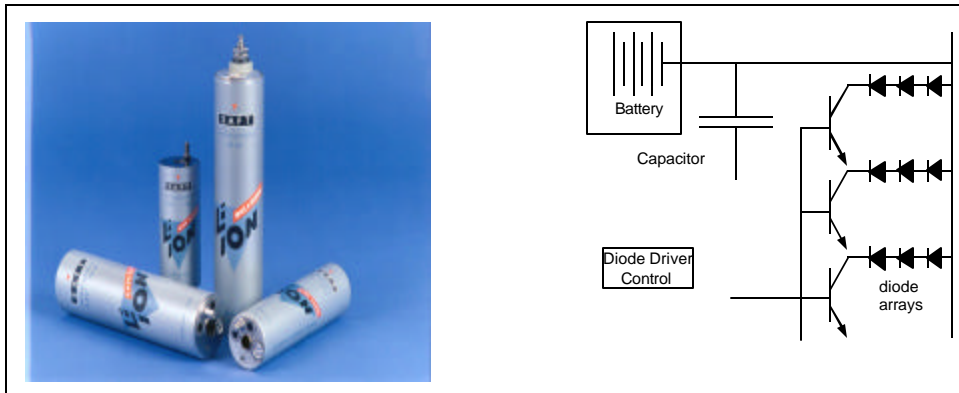

Figure 71. SAFT LiIon Batteries and Conceptual Diode Driver Circuit

Table 3. Total SSHCL Weapon system weight estimates for VHP and UHP Lilon Batteries

Sub-System	Weight (kg)	
	Lilon VHP	Lilon UHP
Control and Communications	20	20
Laser System	250	250
Beam Control System	298	298
Power Supply	1,812	732
Thermal Management System	889	889
Total	3,269	2,189

The thermal management system (TMS), as schematically illustrated in Figure 72, contributes a great deal of weight to the system because of a high heat removal rate and the need to reject the heat through a refrigeration system. The peak heat duty comes from the diode arrays during the firing period and is ~525 KW total. In order to maintain the desired pump wavelength, the diode array coolant must operate at ~20°C with a $\leq 5^\circ\text{C}$ rise. Because the design hot ambient temperature is 55°C, the heat must be rejected through a refrigeration cycle. The high heat duty would result in a very large refrigeration system if the heat were rejected to ambient at the rate it is generated.

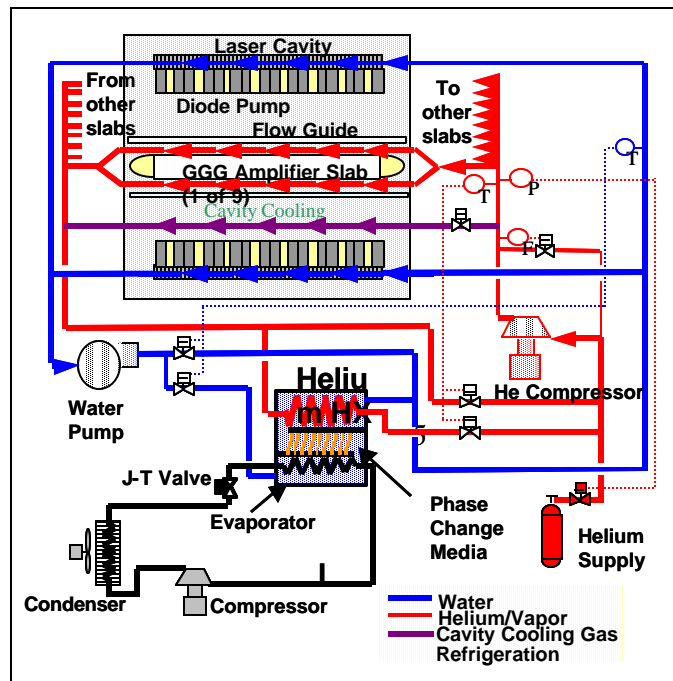

Figure 72. TMS Schematic Arrangement with Thermal Storage

However, using the principle of heat storage, and rejecting the heat during a convenient longer time period, the refrigeration system size can be reduced. With proper selection of the heat storage medium, a trade-off between the heat storage system weight and refrigeration system weight produces a net TMS weight reduction. For the demonstration SSHCL, the heat rejection period was selected to coincide with the battery recharge period of 30 minutes. This would occur after three or more magazines of firing. A phase-change media was used in order to take advantage of the latent heat of fusion to minimize heat storage system weight.

The TMS system for the demonstration program is based on cooling the amplifiers with helium, which achieves a magazine reset time of 90 to 120 seconds. Advanced amplifier cooling development, sponsored by the DoD Joint Technology Office, will enable reset times in the range of 15 to 25 seconds, depending on the amplifier design.

The basic conclusions from this brief study relative to the 100 KW SSHCL demonstrator are:

- The weapon system will fit within the 7 m³ HE-HMMWV payload space with margin.
- The HE-HMMWV payload weight limit can be met with advanced LiIon batteries.
- Investments in advanced battery (e.g., LiIon UHP batteries) and thermal storage research and development will have a very good payoff for future solid state laser weapon concepts.

Moreover, the demonstration program provides a meaningful baseline from which to scale-up or scale-down for FCS weapon concepts. The demonstrator incorporates all the design challenges of the objective system including system integration within performance, platform, and transportability requirements and selected system operations that can be extrapolated to battlefield conditions. Based on this study, a preliminary estimate was made on the effect of increasing or decreasing laser average power on system weight. The result, given in Figure 73, shows that 50 and 300 KW average power SSHCLs would weigh ~1,500 and ~6,000 kg, respectively. A curve drawn between the three points indicates a scaling exponent of ~0.8 for weight as a function of average laser power. The volume relation would be similar. This layout and weight study with scaling projections suggests that the SSHCL is a viable weapon system candidate for many platforms.

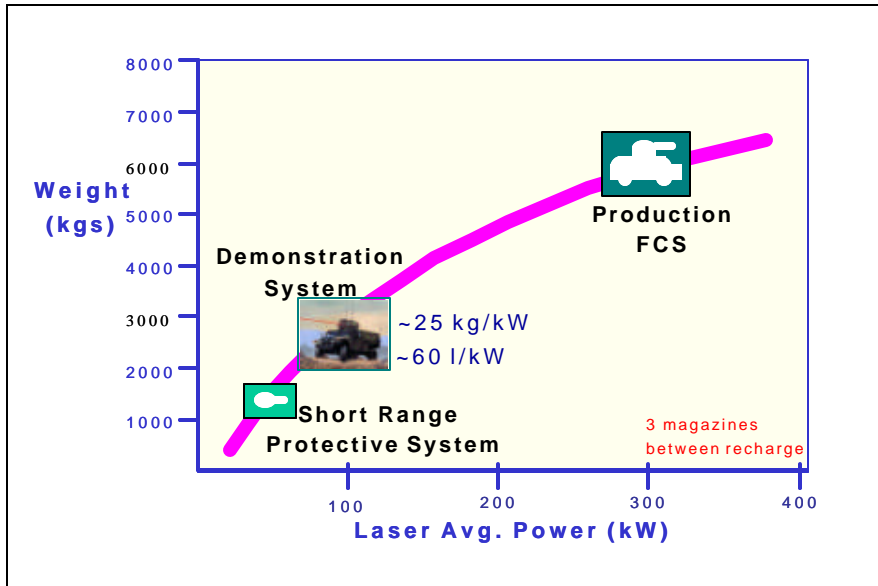

Figure 73. Projected Scaling of SSHCL Weight as a Function of Average Laser Power

**CHAPTER IV. SCIENCE AND
TECHNOLOGY NEEDS**

Although the patent for the laser was issued in 1960, and one was built the same year, significant developments in laser and coherent optics technologies continue to be made. The laser will be nearly 50 years old by the time the Airborne Laser is operational. This period of a half-century, in which the laser has progressed from a theoretical object of basic research to an operational technology, is consistent with technology development in many other areas. The hologram, for example, was first described in 1947, but it was not until 1964 that a three-dimensional holographic image was produced.

Is it feasible, within the next two decades, to include HEL systems on aircraft, space vehicles, ships, and ground vehicles. But there remain formidable science and technology challenges that must be addressed. Work must be done on lethality, atmospheric effects and compensation, a variety of laser sources, beam control, power generation and storage, thermal management, and optics. To realize the potential of HEL systems, a new science and technology investment strategy is needed in addition to considerably more funding. This chapter discusses the current HEL science and technology program and recommends areas in which further research should be conducted.

HIGH-ENERGY LASER PROGRAM FUNDING

Funding for the DoD high-energy laser program in FY 2001 totals about \$474 million, as shown in Table 4. More than half of this funding, about \$251 million, is for acquisition programs, principally the ABL. S&T funding comprises the remainder of the budget, about \$223 million, but more than half of these resources are devoted to the large SBL IFX demonstration program. Another significant amount is in the THEL ACTD demonstration program. Combined, these two large demonstration programs account for two-thirds of the S&T funding. The technology developed under these programs tends to be directed to program-specific requirements.

Moreover, funding from the Navy and HEL Joint Technology Office, nearly \$35 million, is a result of a Congressional supplemental to the DoD budget. Thus core S&T funding available for long-term advanced research and development is only about \$40 million—less than 10 percent of the total budget of close to half a billion dollars.

Given the many technology needs described in this chapter, core S&T funding is inadequate. The task force believes that *the core S&T funding for high-energy lasers needs to be increased by \$100-150 million per year.*

Table 4. Funding for DoD HEL Programs in FY 2001

Program Element	DoD Organization	Title	\$M
0602307A	Army	Directed Energy	0.50
0602605F	Air Force	Directed Energy Technology*	16.00
0603605F	Air Force	Advanced Weapons Technology*	24.70
0602111N	Navy	Air & Surface Weapons Technology*	5.25
0602890D	HEL JTO	HEL Research	29.72
0603308A	Army	AMDS Integration (THEL)	14.20
0603876F	Air Force	Space Based Laser (IFX)	63.20
0603924C	BMDO	Space Based Laser (IFX)	69.80
		S&T Total	223.37
0605605A	Army	HELSTF-SSL	20.00
0603319F	Air Force	ABL PDRR	231.49
		Acquisition Total	251.49
		HEL Grand Total	474.86

Source: *High Energy Laser Program Annual Report to Congress*, 15 February 2001

*Program element includes non-laser efforts; only laser-related funding is given.

S&T PROGRAM PHILOSOPHY

Additional S&T funding is necessary for making high-energy lasers viable as weapon systems, but it is not the only step needed. The funds must also be well directed at those technologies with the most potential to enable new weapons systems. It appears that current S&T funds are too often used to provide incremental improvements to old technology or to develop technology that has no growth path towards militarily useful systems. A change is needed in the way HEL technology investment programs are structured.

Figure 74 illustrates a new approach. In this figure, program performance (such as lethal range) is plotted against program cost. System size is depicted by the size of the circle on the plot. Three regions are indicated: desirable, acceptable, and unacceptable. Desirable systems fall in the region where cost and size are small, and performance is above a minimum threshold. The current state of HEL technology does not support any system concepts in this region. In particular, it does not support any tactical concepts, which must fall in the low-cost, small-size region.

In the intermediate region, cost and size are large but performance is adequate to justify the acquisition of small quantities of systems. Current HEL technology supports the ABL system in this region. For all other HEL systems concepts, including SBLs, mobile tactical systems, and ship-defense systems, additional advances in HEL technology, are needed for a viable combination of cost, size, and performance. For example, tactical technology as represented by the THEL system is clearly too heavy for mobile systems, too costly by an order of magnitude, and too limited in range by atmospheric effects to make an acceptable system for the Army.

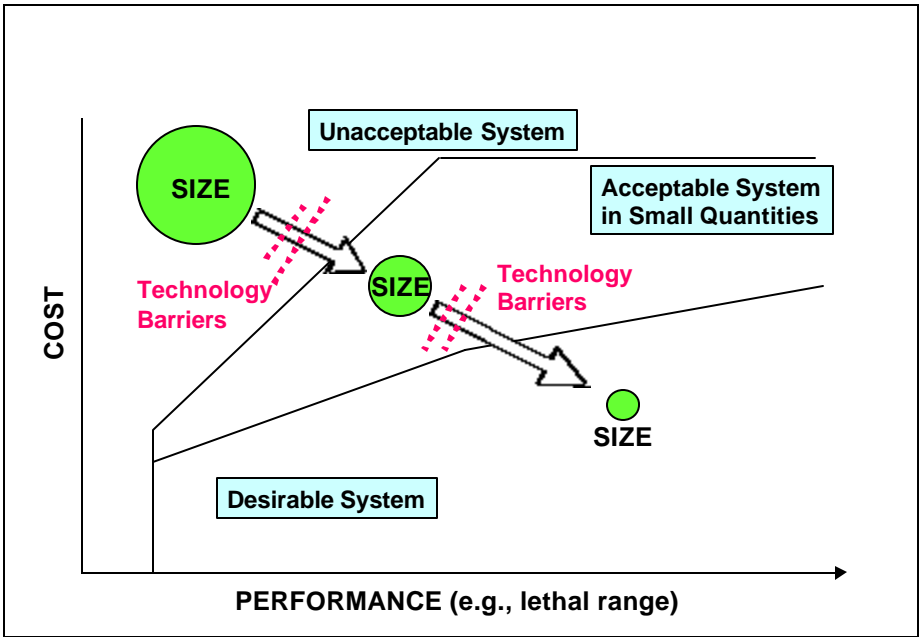

Figure 74. HEL System Considerations

Many current S&T efforts are not focused on developing the leap-ahead technology necessary to enable systems concepts with desirable cost and size. For example, the Air Force and the HEL JTO are funding efforts to modestly improve the efficiency of COIL lasers and to improve atmospheric compensation for ABL scenarios. These incremental improvements will benefit the ABL program by extending the lethal range, but they will not result in the size and cost reductions necessary to enable other airborne HEL missions.

What is needed is a *new DoD investment strategy for targeting HEL S&T funding*. This strategy should have three elements:

- Determine, at a top-level, desired cost, size, lethal range, and other factors for a given system for various HEL missions. Achieving these objectives for a particular HEL system would make that system attractive for Service acquisition.
- Assess the critical technology barriers to achieving the desired system capability.
- Fund those technologies that have the potential to penetrate or bypass identified technology barriers.

TARGETING S&T INVESTMENT

Even in the absence of a comprehensive investment strategy, there are certain technology areas that should obviously be pursued. This section identifies nine areas where increased S&T funding could have significant impact overall at the system level. Annual budget increases are suggested in each of these areas.

LETHALITY

Pursue a vigorous program to quantify the potential advantages of short-pulse lasers (\$5M).

Understanding lethality is key to the design of any HEL weapon system. It has been postulated, and there is some evidence to suggest, that short-pulse lasers have some lethality advantages over CW lasers. Such advantages could be critical to the utility of solid-state lasers for HEL applications. Thus, it is imperative that a comprehensive measurements and analysis program be conducted to definitively compare the lethality of short-pulse lasers with that of CW lasers.

Such a lethality program could have a major impact on the choice of laser for HEL systems and on the detailed design of that laser. If the lethality program does find significant advantages for short-pulse lasers, it could result in major reductions in overall system size and cost. Lethality is also strongly dependent on propagation effects and using short-pulse lasers can introduce additional limitations on laser propagation. Thus, any exploration of short-pulse lethality needs to include investigations of real-world, far-field effects introduced by laser propagation through the atmosphere.

ATMOSPHERIC PROPAGATION AND COMPENSATION

Greatly expand efforts to understand and correct for atmospheric effects, especially in tactical scenarios (\$15M).

Adaptive optics for atmospheric compensation has been pursued for many years and has, in fact, been a key enabling technology for the ABL program. Much remains to be done, however, particularly for tactical scenarios, where little work has been done over the past 20 years. A robust program of field measurements and compensation experiments, including novel adaptive optics and nonlinear phase conjugation, is needed to determine the propagation limits in Army and Navy tactical scenarios. Even apparently modest improvements in lethal range—such as an increase from 2 to 4 km—could have significant impact on system utility.

MODELING AND SIMULATION

Significantly improve the fidelity of modeling and simulation for lasers, beam control, propagation, lethality, and overall system performance (\$10M).

Modeling and simulation in the HEL community has not kept pace with advances in other high-technology areas. In many high-tech fields, advanced modeling and simulation has resulted in a dramatic decrease in requirements for expensive testing. The HEL world, however, still seems stuck in the cut-and-try mode of building expensive systems to see how they will work. Even after building and testing a system the HEL community does not have adequate computational tools to extrapolate those measured results to other system constructs. The THEL program gives a particular example: even for a relatively mature chemical-laser technology the raw output power of the laser was not predicted to better than 30 percent (to say nothing of other, more detailed laser characteristics). Vigorous efforts should be initiated to improve HEL modeling and simulation capabilities across the board—including lasers, beam control, propagation, lethality, and overall systems performance.

DEPLOYABLE OPTICS

Start a new program in lightweight, high-power deployable optics for space-based systems (\$20M).

It is apparent that deployable optics constitute the *sine qua non* for space-based HEL systems, including the SBL and relay-mirror systems. Yet deployable optics are not currently included in the SBL IFX. They exist only as an unfunded requirement in the overall SBL program, and they are being pursued only at a low level elsewhere. It should be noted that the NASA work in deployable telescopes for astronomical imaging,

although relevant, leaves out much that must be considered to develop a high-power telescope. A major new S&T program is required in this area.

SOLID-STATE LASERS

Vastly increase technology efforts focusing on 3 keys to high energy: 1) phased combining of laser modules, 2) design and manufacturing of reliable diode pump lasers, and 3) thermal control of laser media. (\$25M)

Solid-state-laser technology (including fiber-laser technology) is often presented as the enabling technology for new HEL missions, particularly tactical missions. Yet, because of the large demonstration programs such as SBL and THEL, more S&T dollars continue to be spent on chemical lasers. Consequently, chemical lasers remain orders-of-magnitude ahead of solid-state lasers in output power.

To make solid-state lasers competitive with chemical lasers for HEL applications requires vastly increased funding. Solid-state lasers are unlikely to ever scale to high energy in a single module; thus, phasing of laser modules needs to be pursued. Some work is ongoing in this area but needs to be expanded.

Inexpensive, reliable diode lasers are essential for pumping high-energy solid-state lasers. However, the industrial base in this key area has receded, such that there is no longer a reliable vendor willing to develop and make diode lasers that will satisfy DoD needs. Thus, not only is basic S&T work needed in this area, but the S&T work should be done so as to develop a reliable manufacturing source. Because thermal control is the bane of all solid-state laser systems, it needs to be considered as an integral part of all solid-state laser development activities, and thermal-control solutions need to be designed into laser systems from the beginning.

COIL LASERS

Develop technology to make COIL appropriate for SBL and tactical applications: 1) operation in zero-gravity environment and 2) truly closed-cycle operation. (\$5M)

Technology allowing COIL lasers to produce high power at reasonable weight was a critical enabling technology for the ABL. COIL lasers could potentially be attractive for space-based applications and for tactical applications, if certain technology hurdles were cleared. For space-based applications technology must be developed to permit operation in a zero-gravity environment. For tactical applications the key technology is closed-cycle operation. Some work is going on in quasi-closed-cycle operation, in which after a minute or so of run time a pump-out truck

reconstitutes the laser fluids. A better long-term technology goal would be to develop a truly closed-cycle system, in which the laser could operate continuously, circulating and reconstituting fluids as it ran.

HF/DF LASERS

Develop and demonstrate a laser with good beam quality (either naturally or with adaptive optics). (\$10M)

HF/DF lasers have demonstrated weapons-level output power but have not demonstrated good beam quality at high-output power. For most HEL applications both high power and good beam quality are required. Thus, for HF/DF lasers to be competitive for applications such as the SBL, it is essential that good beam quality be achieved in a high-power laser. The beam quality could be achieved with either passive techniques or adaptive optics, but it must be verified with measurements of the high-power beam.

BEAM CONTROL

Initiate a long-range effort in novel techniques such as phased-array beam control and electronic beam steering. (\$10M)

The size and weight of HEL systems can be driven by very large conventional telescope systems. For some applications it should be possible, at least in principle, to replace the functions of the conventional telescope with some sort of phased-array or electronic beam steering. Such a scheme might be particularly appropriate for an HEL comprising many fiber lasers. At this juncture such novel beam-control schemes are ill defined and speculative, but given the potential of such schemes to radically reduce size, weight, and cost of an HEL system, it seems worthwhile to invest in them for the longer term.

OPTICAL COMPONENTS

Significantly increase technology development to improve system performance and preserve a fragile manufacturing base. (\$10M)

HEL systems depend on a vast array of basic and integrated optical components, including optical substrates, coatings, detectors, deformable mirrors, and wavefront sensors. Advances in these areas have been vital for HEL systems. For instance, the basic development of low-absorption coatings was a key enabling technology for the ABL: it obviated the need for cooled mirrors, which resulted in large savings in size, weight, and complexity. Currently, the range of the THEL system is apparently limited not by the high-power laser, but by the range capability of the tracking system. It would appear that developing a Geiger-mode

avalanche photodiode array for the THEL tracker focal plane could significantly increase the range, with no increase in system size.

DoD support for basic optical component development has dwindled drastically in recent years. Reduced HEL S&T funding and increased competition from the commercial telecommunications market have decreased the number of HEL component suppliers. The situation is particularly critical in components such as optical coatings and detectors, in which one needs both skilled personnel for design and fabrication (which are sometimes more art than science) and large capital investment in fabrication facilities. As an example of the problem, OCLI, which has for many years been the number one specialty optical-coating house for HEL applications, recently told the ABL SPO that, after fulfilling current commitments, it would not do further ABL coatings. Thus, increased S&T funding is needed in this area both to improve HEL system performance and to maintain organizations able to fulfill HEL component-fabrication needs.

FREE-ELECTRON LASERS

Substantially increase technology efforts focusing on key elements of 1) scaling free-electron lasers to higher powers and 2) demonstrating ability to field in a military environment. (\$25M)

The FEL is an all-electric laser that is a dark-horse competitor to the solid-state laser. It may, in fact, be scalable to much higher powers than the solid-state laser. FELs are particularly attractive for ground-based laser and shipboard applications, for which very high power and wavelength selectability are important but extreme compactness is not. A recent demonstration of 1.7 KW average power has put the FEL in the same regime as state-of-the-art solid-state lasers. The current program to scale this same FEL to 10 KW, which is exceptionally important to understanding any physics limitations for this technology, is on a parallel and competitive path with current plans to build a 10 KW solid-state heat-sunk slab laser.⁹ In principle, FELs should scale to high power more easily than do other lasers: to first order, to obtain more power from an FEL it is only necessary to increase the energy in the electron beam by increasing the average current. Theoretical calculations have shown that FELs have the potential to scale to multi-megawatts.

There are, however, many technical challenges to developing a high-power FEL. For instance, a critical challenge is maintaining or even improving electron-beam brightness as current in the beam is increased.

⁹ Appendix E contains a summary of the FEL programs being conducted at Thomas Jefferson National Accelerator Facility (Jefferson Laboratory) and at Los Alamos National Laboratory.

Another concern for FELs, which have typically been large laboratory devices, is making them compact and rugged enough for military applications. A substantial reduction in size might be achievable by developing the technology to increase the accelerator operating frequency from the current 0.5-1.5 GHz to, for example, 50 GHz. Overall, what is needed for FELs is a broad-based S&T program aimed at developing the technology necessary to field a 100 KW laser on a ship (perhaps a barge). Such a system could then be used in related S&T efforts to explore FEL-specific beam-control, propagation, and lethality concerns in a realistic environment.

TASK FORCE FINDINGS

1. The core HEL S&T funding is insufficient to realize the clearly defined potential contribution of HEL to future military capabilities. Considerably more funding (\$100-150 million per year) is needed.
2. A new DoD HEL S&T investment strategy is needed. The strategy should be based on determining top-level systems needs, assessing critical technology barriers to meeting those needs, and funding the research needed to overcome the barriers. In the face of funding pressures, the practice of providing inadequate funding to a wide variety of programs should be replaced with focused, sequential developments funded at the level of effort needed to make real progress.

CHAPTER V. RECOMMENDATIONS

Appropriately developed and applied, directed energy can become a key contributor to the 21st-century arsenal. Success for directed energy requires hard and expensive work to mature the technology and apply it operationally in appropriate ways. In the relatively near term, the new capabilities afforded by the use of high-power laser technologies could improve numerous aspects of warfare from initial detection and identification of targets to battle damage assessment after their attack. High-energy laser weapon systems could be significant force multipliers providing “speed-of-light” engagement, unique damage mechanisms, greatly enhanced multi-target engagement and deep magazines limited only by the fuel available. The use of these weapons offers the opportunity for the strategist to select from a range of possible effects to the target system—from non-lethal to lethal.

The task force supports continued development of HEL systems, but emphasizes the need for a sustained, department-wide science and technology investment funded with significantly more resources than are currently allocated.

Based on its evaluation of current initiatives, new applications, and key science and technology needs, the task force offers the following recommendations:

1. Airborne Laser

While continuing to focus the PDRR phase on earliest practical deployment, the Air Force should fund a robust technology effort to evolve to a more capable and supportable future system.

The Air Force should program the PDRR aircraft for continuing evolution of ABL capabilities by the development community, while further developing the concepts of operations.

2. Space-Based Laser

- **IFX.**

BMDO should:

Give high priority to reducing the high-risk elements in the currently planned IFX program.

Reevaluate the relative cost and schedule risk of the current plan to bundle multiple high-risk elements into a first in-flight experiment versus a series of lower-risk experiments preceding and following the first attempted lethal demonstration.

Include deployable optics technology development as part of a comprehensive S&T program along with other necessary SBL S&T efforts.

- **Initial operational system.**

BMDO should:

Fund a robust S&T effort to address the significant scaling required in going from IFX to operational capabilities. Specific efforts should include short-wavelength space-, aircraft-, and ground-based laser sources.

Intensify the development efforts to provide options for the growth path to IOC—deployable optics, short-wavelength lasers, beam control, and space support technologies.

Develop an on-orbit servicing and assembly capability through technology development and on-orbit demonstrations.

Conduct a continuing cost and risk trade-off between (1) size and weight reduction to fit planned launch capabilities and (2) increased lift capacity, to make a timely decision on launch capability needs.

- **Further operational system upgrades.**

The USD(AT&L) should pursue advanced technologies to include solid-state and closed-cycle chemical lasers. This research should be part of the robustly funded S&T effort.

As technology develops, BMDO should evaluate a balanced system of space-based lasers, airborne lasers, ground-based lasers, and space-based mirrors to meet the BMD mission need.

3. High Energy Laser – Tactical Army

While continuing to move towards deployment of a mobile system using a deuterium fluoride chemical laser, the Army should broaden efforts toward development of laser technologies for a more robust, supportable system—closed-cycle chemical, solid-state, and fiber lasers. Program options for choosing a new laser should be kept open as long as possible.

4. New Applications

The USD(AT&L) should establish a continuing review program involving the Services, Joint Chiefs of Staff (JCS), and OSD to evaluate operational potential of high-power laser applications as technologies mature. Include:

- Advanced Tactical Laser.
- Ground-Based Laser.
- Evolutionary Aerospace Global Engagement System.

- Tactical High Energy Laser – Fighter.
- Future Combat System applications.
- Countermunitions.
- Maritime Self-Defense.
- Large-Aircraft Self-Defense.

5. Technology Program

The USD(AT&L) should create a coherent, department-wide, prioritized technology program to support the growing family of potential HEL applications. The needed increase in funding is judged to be \$100 to \$150 million per year. The program should include the following:

- *Lethality.* Pursue a vigorous program to quantify the potential advantages of short-pulse lasers, and develop a predictive capability at a system level to support HEL system fire control and battle space management.
- *Atmospheric Propagation and Compensation.* Greatly expand efforts to understand and correct for atmospheric effects, especially in tactical scenarios. Compensation for scintillation effects should be included.
- *Modeling and Simulation.* Significantly improve the fidelity of modeling and simulation for lasers, beam control, propagation, lethality, and overall system performance. More accurate wave optics models should be developed. More extensive comparisons between models and data are needed.
- *Deployable Optics.* Start a new technology development program in large, lightweight, deployable optics for high-power space-based applications.
- *Solid-State Lasers.* Increase technology efforts focusing on four keys to high energy: 1) combining laser beams, 2) designing and manufacturing reliable diode pump lasers, 3) improving thermal control of laser media, and 4) scaling the output power and weight/cost per watt to weapon class systems.
- *COIL or other Iodine-based Lasers.*
 1. Develop technology to make laser sources appropriate for space and tactical applications: 1) capable of operation in a zero-gravity environment, 2) capable of closed-cycle operation, and 3) lighter weight.

2. Evaluate novel approaches to pumping chemical lasers including electrical and optical methods.
- *HF/DF Lasers.* Demonstrate a nearly diffraction-limited beam at high power (either uncorrected or with adaptive optics).
 - *Beam Control.*
 1. Develop low-cost components, optical metrology, and alignment techniques, and integrate propagation and lethality predictions into the HEL system description.
 2. Initiate a long-range effort in novel techniques such as phased-array beam control, electronic beam steering, and non-linear phase conjugation.
 - *Optical Components.* Significantly increase technology development to improve system performance and preserve fragile manufacturing base.
 - *Free-Electron Lasers.* Substantially increase technology efforts focusing on key elements of: 1) scaling FELs to higher powers and 2) demonstrating the ability to field for military applications. Specific investment areas include high average current injectors, electron beam transport, high-power optical resonators, beam expanders, and undulators.

APPENDICES

**APPENDIX A. TERMS OF
REFERENCE**



THE UNDER SECRETARY OF DEFENSE

3010 DEFENSE PENTAGON
WASHINGTON, DC 20301-3010

OCT 11 2000

MEMORANDUM FOR CHAIRMAN, DEFENSE SCIENCE BOARD

SUBJECT: Terms of Reference--Defense Science Board Task Force on High Energy Laser
Weapon Systems Applications

You are requested to form a Defense Science Board (DSB) Task Force on military applications of high energy laser (HEL) weapon systems. The Tactical High Energy Laser (THEL) Advanced Concept Technology Demonstration's successful shoot downs of tactical rockets indicates that laser weapon technologies may possess the maturity to begin integrating them into operational forces.

In the 1990's, a variety of programs to develop applications for HEL technologies for a wide variety of military uses were initiated and are currently being pursued by the Services. Interest grew in the operational use of lasers for mission areas such as air and missile defense and precision attacks. A wide variety of technology advancements support these system developments – both in commercial industries as well as in the military laboratories. During this period the technology has developed rapidly in key enabling sub-systems areas.

HEL systems appear to provide the Department with unique opportunities that have the potential to augment or improve operational capabilities and tactics in several areas. In order for the Department to effectively incorporate HEL weapon systems into warfighting operations at the earliest possible opportunity, the task force is to:

Review current programs in HEL applications.

Examine recent supporting technology advancements and their applications with respect to supporting military HEL weapon system developments.

Develop potential military tactical and strategic HEL system applications and identify processes required to implement these potentials.

- Determine what remains to be done to "weaponize" these systems, including measures needed to allow them to operate and be supported in applicable combat theater environments.

Assess HEL operational concepts, impacts and limitations, considering legal, treaty, and policy issues concerning HEL employment.



Make recommendations on:

Needed additional research efforts that are not currently being addressed by the Department. These recommendations should encompass supporting technologies that enable military HEL applications.
Potential strategic and tactical impact of HEL systems on future military operations compared to use of current systems.
Capabilities of the U.S. defense industrial base to support development of HEL systems.
Transition paths or roadmap for HEL weapons development and military applications.

The Task Force should provide a final report by May 31, 2001. This Task Force will be co-chaired by Gen Larry Welch, USAF(Ret) and Mr. Don Latham.

The Task Force will be sponsored by the Under Secretary of Defense for Acquisition, Technology and Logistics, the Director, Strategic and Tactical Systems, and the Director, Ballistic Missile Defense Organization. Dr. James Mulroy, Strategic and Tactical Systems (Missile Warfare) will serve as Executive Secretary; and Major Tony Yang, USAF, will serve as the DSB Secretariat Representative.

The Task Force shall have access to classified information needed to develop its assessment and recommendations.

The Task Force will be operated in accordance with the provisions of P.L. 92-463, the "Federal Advisory Committee Act," and DoD Directive 5105.4, "The DoD Federal Advisory Committee Management Program." It is not anticipated that this Task Force will need to go into any "particular matters" within the meaning of Section 208 of Title 18, U.S. Code, nor will it cause any member to be placed in the position of acting as a procurement official.

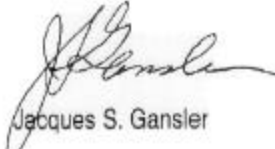

Jacques S. Gansler

**APPENDIX B. TASK FORCE
MEMBERSHIP**

Co-Chairs

Mr. Donald Latham	General Dynamics Corporation
Gen Larry Welch, USAF (Ret)	Institute for Defense Analyses

Members

Gen John Corder, USAF (Ret)	Consultant
Dr. Bill Graham	National Security Research (NSR)
Dr. Ronald Kerber	Whirlpool Corporation
VADM Conrad Lautenbacher, USN (Ret)	Consortium for Oceanographic Research and Education
Gen Robert Marsh, USAF (Ret)	Air Force Aid Society
Mr. Walt Morrow	MIT Lincoln Laboratory
GEN Glenn Otis, USA (Ret)	Consultant
Dr. Bruce Pierce	Photon Research Associates, Inc.
Dr. Richard Wagner	LANL

Executive Secretary

Dr. James Mulroy	OUSD(AT&L)/DR&E/S&TS/ MW
------------------	--------------------------

DSB Representative

LtCol Tony Yang, USAF	Defense Science Board
Maj Roger Basl, USAF	Defense Science Board

Government Advisors

Dr. Darrell Collier	US Army Space and Missile Defense Command Task Force FCS
MG Joseph Cosumano, USA	Ballistic Missile Defense Organization
Dr. Douglas P. Crawford	Directed Energy Directorate
Mr. Edward Duff	Air Force Research Laboratory
LtCol Terry Franks, USAF	HEL-JTO
Maj. Franz Gayl, USMC	Space Plans & Policies Action Officer PP&O, HQMC
Dr. Gene McCall, USAF	HQ AFSPC/CN
Dr. Tom Meyer	DARPA
Dr. Stephen Post	ODUSD(S&T)/WS
Dr. Charles Primmerman	HEL Joint Technology Office, Office of the Deputy Under Secretary of Defense (S&T)

Dr. Ralph Schneider

Office of Secondaries and Inertial
Fusion (DP-131)

Mr. Mike Wardlaw

NAVSEA

Task Force Staff

Ms. Barbara Bicksler

Strategic Analysis, Inc.

Ms. Julie Evans

Strategic Analysis, Inc.

Mrs. Tyra Flynn

Strategic Analysis, Inc.

**APPENDIX C. BRIEFINGS RECEIVED
BY THE TASK FORCE**

October 19-20, 2001	
<i>Name</i>	<i>Topic</i>
Col. Doug Owens	USAF Directed Energy Integrated Needs Methodology
LtGen Stephen Plummer, USAF	USAF Directed Energy Master Plan
MajGen Don Lamberson, USAF (Ret)	Directed Energy Applications for Tactical Airborne Combat (DE-ATAC)
Dr. Darrell Collier	Army Directed Energy Program (USASMDC)
Dr. Rick Hake	HEL SBL Architecture and Affordability Study
Mr. Mike Wardlaw	Navy Directed Energy Plans
Mr. Bill Thompson	Air Force Study of HEL Industrial Base
Gen John Piotrowski (Ret)	1998 Study, Lasers and Space Optical Systems (LASSOS)
Dr. Vern Schlie	Tactical High Energy Laser Fighters
Dr. Rick Wallace	Advanced Tactical Laser
November 14-15, 2001	
<i>Name</i>	<i>Topic</i>
LtCol Terry Franks, USAF	HEL Joint Technology Office (JTO) Overview
Dr. Darrell Collier	JTO Solid State Laser Working Group (WG)
Mr. Ed Duff	JTO Chemical Laser WG
Dr. Eli Zimet	JTO Free-Electron Laser WG
Mr. Ed Duff	JTO Beam Control WG
Jorge Beraun	JTO Lethality WG
Maj Franz Gayl, USMC	Marine Corps Directed Energy Plan
Mr. Jake Mentz	Legal/Treaty/Policy Issues
Joung Cook	Navy HEL Technical Issues
Dr. Steve Lamberson	Adjunct Mission for ABL
Dick Bradshaw & Jerry Wilson	THEL Program Overview
Dr. Thomas Romesser	TRW Directed Energy Portfolio

December 14-15, 2001	
<i>Name</i>	<i>Topic</i>
Lt. Col. J. R. Jordan and Fritz Benning	SBL-Part I and II
Mr. Marc Berkowitz	Illumination of Objects in Space by Lasers
Mr. Jerry Wilson	THEL
Maj Duncan Dversdall	DECAT
Dr. Michael Skolnick	Boeing-HEL Overview
Col Ellen Pawlikowski, USAF	ABL
January 25, 2001	
<i>Name</i>	<i>Topic</i>
Mr. Steve McElroy	Raytheon Electronic Systems- HEL Overview
Mr. Jack Hammond	Lockheed Martin- HEL Overview
Pete Varmette	Intel
Dr. George Neil and Dr. Fred Dylla	Jefferson Laboratory FEL Program
Dr. Ken White	HELSTF
Dr. Bill Goldstein	Livermore DOE Perspective
February 21-22, 2001	
<i>Name</i>	<i>Topic</i>
Mr. Jim Riker	SBL
Col Ellen Pawlikowski, USAF	ABL
Dr. Charles Primmerman	Status of JTO Awards
Dr. Bob Beland	Weather
Dr. Barry Hogge	Beam Control
Capt Amy Robinson, USAF	Satellite Protection
Bill Woody	Satellite Protection and Related Issues
LtCol Patrick McDaniel, USAF	Satellite Assessment Center
March 13-14, 2001	
<i>Name</i>	<i>Topic</i>
Dr. Jerry Beam	Electric Power and Thermal Management
Mr. Dan Herrera & Mr. Gus Khalil	Army Combat Hybrid Power System (CHPS)
Dr. Cliff Muller	HEL System Packaging
Robert Schliecher	HMMWV SSL Point Design
Dr. Michael Perry	Solid-state and Short-pulse Lasers
Dr. Albert Morrish	Beam Control
Maj Steve Leonard	EAGLE-Relay Mirror Technology Program

Capt. Jeff Barchers	GBL and Relay Mirrors
Dr. Al Ullman	Advanced COIL and Iodine Laser Technology (Part 1) ATL and EC COIL
Dr. Gordon Hager	Advanced COIL and Iodine Laser Technology (Part 2) Ejector Nozzles and Iodine Space Based COIL AGIL (All Gas Iodine Lasers)
Dr. Delores Etter	DUSD(S&T) HEL Overview
April 16, 2001	
<i>Name</i>	<i>Topic</i>
RADM Mathis	Discussion of Navy HEL Programs
John Waypa	TRW Perspectives
Dr. Hyde	LLNL
COL Collins	Discussion of Army Operational Needs
May 15, 2001	
<i>Name</i>	<i>Topic</i>
Dr. Douglas Crawford	SBL Update
Mr. Ed Duff	ABL and Relay Mirrors

**APPENDIX D. SUMMARY OF THE
DIRECTED ENERGY APPLICATIONS
FOR TACTICAL AIRBORNE COMBAT
STUDY**

TACTICAL HEL FIGHTER STUDY – BOEING PHANTOM WORKS, 1999

In 1998-99, the Air Force Research Laboratory sponsored the Directed Energy Applications for Tactical Airborne Combat (DE-ATAC) Study to review possible uses of directed-energy on tactical airborne platforms in combat. This effort identified and prioritized high payoff airborne tactical applications of directed-energy technologies including high power microwave (HPM), HEL, and kinetic energy weapons (KEW). Based on these priorities, the study formulated Air Force investment strategies in key areas of directed-energy technologies.

The Phase I DE-ATAC study recommended further study for five tactical DE concepts, four dealing with HPM and a fifth addressing advanced active sensors using lasers. One of the concepts identified under the DE-ATAC Phase I study was integrating HELs on fighters for tactical operations. Due to weather concerns about its full utility, this DE concept did not go forward as part of the Phase II DE-ATAC study. The logical next step, as suggested by the study, was to examine the utility of placing a high-energy laser on an airborne tactical platform, fighter, and uninhabited combat air vehicle (UCAV). Obviously, such an effort had to provide a *clear, logical, coherent picture* of how weather and environmental atmospheric conditions affect use of HELs for tactical missions. The question became how much can an airborne tactical laser expect to be employed in "weather." Consequently, this study attempted to answer the meaning of "all-weather capability" as defined by today's standards and to evaluate environmental impacts on a variety of tactical HEL missions. The study results are very encouraging. Results show that the presence of clouds and operation of a HEL fighter need not be mutually exclusive events.

This study addressed what weather really means to the use of HELs for tactical fighter missions. The results clearly show, as in other U.S. Air Force tactical operations, weather is not a unique deterrent. The recent Kosovo conflict clearly indicated how bad weather greatly minimizes and often eliminates any and all military operations. As part of this study on HEL weather effects, it was first necessary to identify tactical HEL missions and operations, combat utility, and concepts of operations in order to realistically evaluate the impact of weather for HEL systems on high-performance, tactical fighter platforms.

For the evaluation, a two-step approach was used. The first and most significant step was to establish if a laser weapon system could operate and accomplish select combat mission objectives in a real world environment—that is, in the "weather." The *study process* went accordingly: "If it was determined that this was possible, the next step

would be to set quantitative bounds on what technologies must be developed. The goal would be to determine which are the state-of-the-art of those technologies now, and estimate how far away they are from being judged at a Technology Readiness Level (TRL) of 6.”

Both steps were accomplished successfully. As a result, it was determined that designing, producing, installing, and utilizing a high-energy laser on a tactical fighter platform is within reach of today's scientific, acquisition, and industrial communities, provided proper DoD funding occurs in future years. In addition, such a Tactical HEL Fighter would have high value to the Major Command warfighters in many mission areas. Both current and near-term fighters would be greatly enhanced with such a capability, especially in two intelligence, surveillance and reconnaissance areas: positive target/NCTR identification and target destroy/degrade. In addition, HEL sizing estimates indicate useful lethal tactical HEL missions are feasible for air-to-air/air-to-ground including offensive and defensive engagements, further enhancing the warfighter's capabilities.

For the study of a Tactical HEL Fighter, an Integrated Study Team of government personnel and major command (MAJCOM) warfighters was formed to evaluate the utility of placing an HEL on a tactical fighter. A system engineering approach (really laser-energy budgeting) was used to determine the laser power required on various target sets. The Integrated Study Team first defined and then studied all conceived tactical mission types and profiles including all available threat-target laser vulnerabilities. Newly defined concepts of operations (CONOPS) that would be required for use of HELs on fighters were also developed. All study events resulted from a "strategy-to-task-to-technology" process. Both the environmental and the operational effects that attenuate laser energy propagating from the fighter to target were analyzed. Finally, CONOP solutions were developed to clarify and maximize operational utility in a partly cloudy environment.

MAJOR RESULTS OF TACTICAL HEL FIGHTER STUDY

This Tactical High Energy Laser Fighter Study was a combined effort of aircraft industry, AFRL, and MAJCOMS (ACC/AFSOC). Five major topics were emphasized:

- Missions identification—application use of HELs on tactical platforms.
- Impact of weather—environmental conditions on use of HELs in tactical operations.

- Enabling technologies critical for development and integration of HEL-Beam Control Systems (BCS) on aircraft:
 - Tactically sized 1-100 KW HEL with minimum logistical “trail”.
 - Efficient, small, compact, light-weight, and robust.
 - High brightness ($\lambda \approx 1\text{-}2 \mu\text{m}$) for lethal/non-lethal missions.
 - 1 KW for enhanced ISR giving long ranges, beyond visual range.
 - Dynamic, advanced BCS compatible with fighter environment.
 - Vibration ally and high compensated—g-factor insensitive.
 - Employ conformal optics to enhance “effective” aperture.
 - Low RCS and IRCM essential for future fighters: F-22 and Joint Strike Fighter.
 - Aero-optics turbulence compensation for near-field, non-free stream.
 - Detailed pulsed and CW effects data for Tactical HEL Fighter “target-sets.”
 - Advanced weather (cloud) predicting models of atmospheric conditions.
- Potential demonstrations for implementing and integrating HELs on fighter platforms progressing from ISR at 1 KW to 10s-100 KW for potential lethal and non-lethal missions.
- Roadmaps for critical technologies, including demonstrations promoting TRL 6.

The study results concluded that the potential is good for both near- and far-term applications of HELs on tactical platforms including its future with UAV and UCAVs. Present “state-of-art” beam control systems coupled to HELs indicates good laser pointing stability should be exhibited by compensating for the aircraft mechanical vibrations and induced turbulence within the free stream region around the tactical air platform. The information provided will be an aiding tool to further advance the potential, the required enabling technologies, and the airborne demonstrations of HEL/BCS on tactical platforms. Finally, a paradigm shift in the warfighter’s CONOPS may occur since the use of HEL on tactically manned platforms may allow the warfighter to “re-capture” the battlefield, again operating at least 15,000 feet or more or greatly minimizing or overcoming detrimental weather conditions.

PRELIMINARY HEL SYSTEM SIZING

The results of this study produced preliminary HEL system aspects leading to potential overall HEL-BCS system sizing as shown in Figure D-1. Such sizing can produce significant advantages to the warfighter and can be integrated on most of the conventional fighter platforms like F-15, -16, -18, and future F-22 and Joint Strike Fighter.

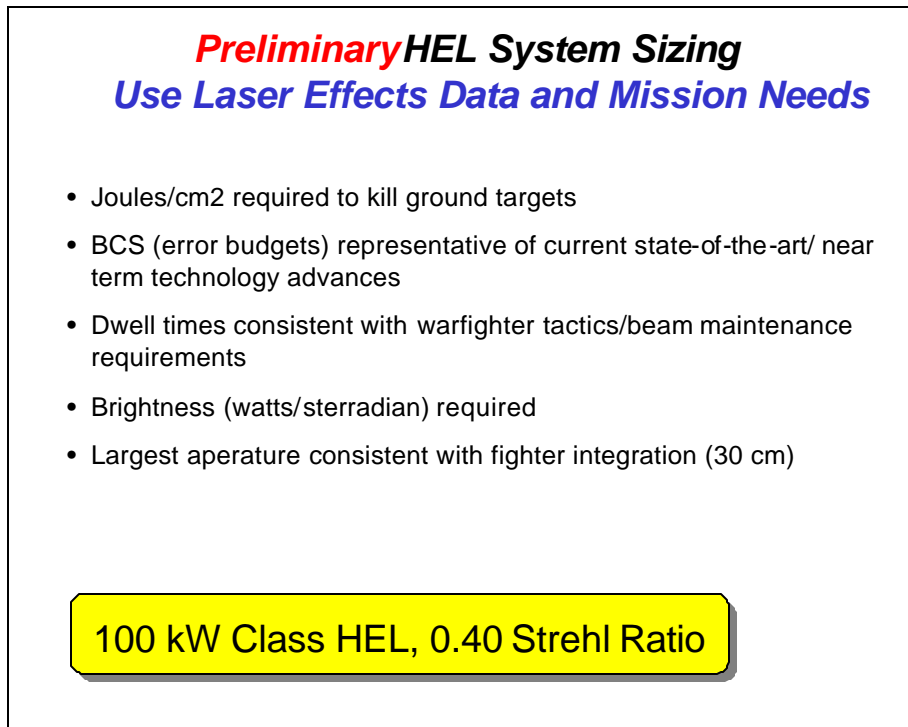

Figure D-1. Preliminary HEL System Sizing

TARGET SET EFFECTS DATABASE: JOINT MUNITIONS EFFECTS MANUAL

The various targets sets have been identified including sensors, canopies, fuel tanks, missile domes, antennas, tires, and many others. Their vulnerabilities to HEL radiation vary from soft targets like sensors to very hard targets like transport-erector launches of integrated air defense systems. Although not extensive, the HEL effects database is sufficient to assess the value of Tactical HEL Fighters. None of the data can be reported here due to its classification. Future efforts need to greatly expand both the CW and pulsed laser vulnerability data to critical target sets.

In the future, the laser target effects database needs to become part of the Joint Munitions Effectiveness Manual in order for the warfighter to be able assess its military worth, versus dropping munitions on specific targets.

IMPLICATIONS OF WEATHER / ENVIRONMENT ON HEL WEAPONS

Critics of high-energy laser weapons on tactical aircraft emphasize the difficulty of propagating laser energy through weather and environmental conditions. This study performed a rigorous assessment of weather and environmental effects to quantify the precise effects on the mission capability of the Tactical HEL Fighter. Due to its importance, significant details of this extensive analysis are included here. They show weather is not a severe limitation on the use of HELs for the warfighter in tactical engagements.

Overview: Weather and Environmental Effects

The evaluation included operational, tactical, and warfighter perspectives, so the weather and environmental effects could be evaluated in the context of how the Tactical HEL Fighter would be used in combat. Figure D-2 lists various obscurants, weather and environmental, which could have a detrimental result on HEL Fighter capability. As shown, naturally occurring effects of moisture, rain, ice, and dust are considered in the weather category. Environmental conditions generally refer to the combat environment, and include man-made effects of smoke, countermeasures, pollution, and chemical/biological weapons.

Weather	Environmental Conditions
Clouds Fog Rain Sleet/Snow Dust Storms Relative Humidity	Smoke (Countermeasures) Debris/Fire/Smoke (Combat Damage) Pollutants Chem/Bio Weapon Clouds

Figure D-2. Variations of Weather and Environmental Conditions

Weather causes differing effects on laser propagation, depending upon the laser wavelength and the type of weather element present—rain, fog,

drizzle, or ice, for example. Figure D-3 shows the wide variability in atmospheric attenuation as wavelength and weather conditions change. The light gray curve represents a rain-free environment of known pressure and relative humidity. This curve can be seen to vary significantly over the full range of laser frequencies, but it also shows several important windows of low atmospheric attenuation. The other curves represent varying levels of precipitation ranging from drizzle to heavy rain and fog. Note that these conditions cause significant attenuation even in the 1 and 10 μ windows. Such data indicates a need for statistical analysis of weather (clouds) in the expected combat scenario. The HEL would perform well in the conditions represented by the gray curve, and poorer in the others. Thus an analysis is needed to quantify the mix of combat conditions in the engagement scenario.

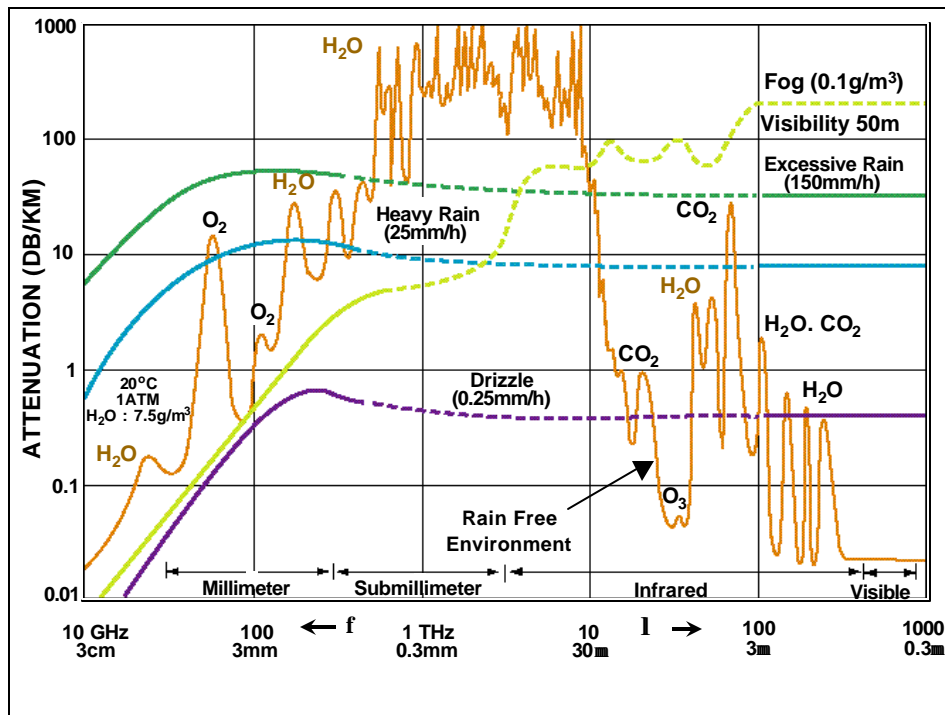

Figure D-3. Atmospheric Attenuation versus Wavelength and Moisture Content

In performing such an analysis, it is convenient to separate the effects of various weather related factors. This is done in Figure D-4, which describes the effects of cloud cover and fog, molecular absorption, molecular scatter, and aerosol scatter.

Cloud Cover & Fog	Molecular Absorption	Molecular Scatter	Aerosol Scatter
<ul style="list-style-type: none"> • Largest attenuator • Function of ceiling 	<ul style="list-style-type: none"> • H₂O primary absorber in boundary layer • Thermal blooming • Function RH, T, P, wind & line broadening mechanism 	<ul style="list-style-type: none"> • Small effect at μm wavelength 	<ul style="list-style-type: none"> • Affects visibility & attenuation • Function of size distribution & number density
Weather Analysis well Anchored with Established Methodology and ISMCS Data Base			

Figure D-4. Effects of Different Species on Laser Propagation

Assessing Weather and Environmental Effects

The methodology for assessing the impact of weather and environmental conditions varies significantly with the type of situation being considered. For example, the effects shown in Figure D-4 are analyzed in different manners. Clouds and fog in the left hand column are identified as the most serious concern. High-energy laser operations in clouds and fog are generally ineffective, so the issue becomes avoiding HEL operations in these environments by careful mission planning and use of alternative tactics or weapons. The other three types of effects in Figure D-4 will degrade laser performance, but will not preclude their use. The assessment of weather in these cases is accomplished by evaluating the variables of climate (temperature, pressure and relative humidity) on a statistical basis. Once the statistical characterization of the climatic variables is factored in, laser system (power-aperture and BCS) requirements can be defined so the system will be effective in the environment. A more detailed description of clouds and cloud free line of site is discussed in an addendum to this appendix.

Cloud Characteristics: Impact on HEL Use

For generations, "weather" has been a key factor in the prosecution of wars. The state of the atmosphere refers to its "clearness or cloudiness" which may affect the operational application of laser weaponry mounted on a tactical fighter platform.

Currently, most warfighters, especially aviators, perceived "weather" as a showstopper. It is not the only problem that will interfere with a Wing Commander's ability to meet his flying hour allocation, but it is the problem over which he has the least control. Such views do not have to be the case and in fact, "weather" can be utilized as a force multiplier by the warfighter. Cloud conditions may produce more opportunities to apply tactical high-energy lasers than the current cloud databases and current military mindset may assume. These opportunities will be found by identifying the existence of "cloud-free arcs" present in the environment. Taking advantage of these opportunities in the future will depend on important developments in weather prediction capabilities.

Weather Related Operational and Tactical Considerations

Probability of cloud free line-of-sight (P_{CFLOS}) is described statistically at the end of this appendix. But how can the warfighter react to situations with varying levels of P_{CFLOS} ? An assessment begins by examining a case where $P_{CFLOS} = 0.8$ —about 20 percent cloud cover on average. This can occur in a number of ways. One extreme would be to have four perfectly clear flying days, followed by one day that is completely cloud covered. This would represent $P_{CFLOS} = 0.8$, but would represent an extreme "all or nothing" case.

Another case where $P_{CFLOS} = 0.8$ would be a situation where an instantaneous examination of the target area would show 80 percent of the approaches to the target to be clear and the other 20 percent would be clouded. This situation is illustrated in Figure D-5 and would represent a case where the instantaneous or snapshot look at the target area also represents the P_{CFLOS} . Actual combat situations will probably lie somewhere in between the two extremes.

When viewing Figure D-5 from a combat perspective, most aviators and military analysts would feel that it represents little challenge to the HEL fighter aircrew. If the pre-planned ingress route happened to take the aircraft through the narrow clouded sector, it would only require a small variation of flight path to achieve a clear line of sight to the target. On the other side of the numerical spectrum, there could be cases where $P_{CFLOS} = 0.2$. These cases could also be represented by the two extremes ("all or nothing" to "snapshot"), but it is interesting to look at the snapshot case to speculate what HEL options the aircrew might have. Such a situation is pictured in Figure D-6.

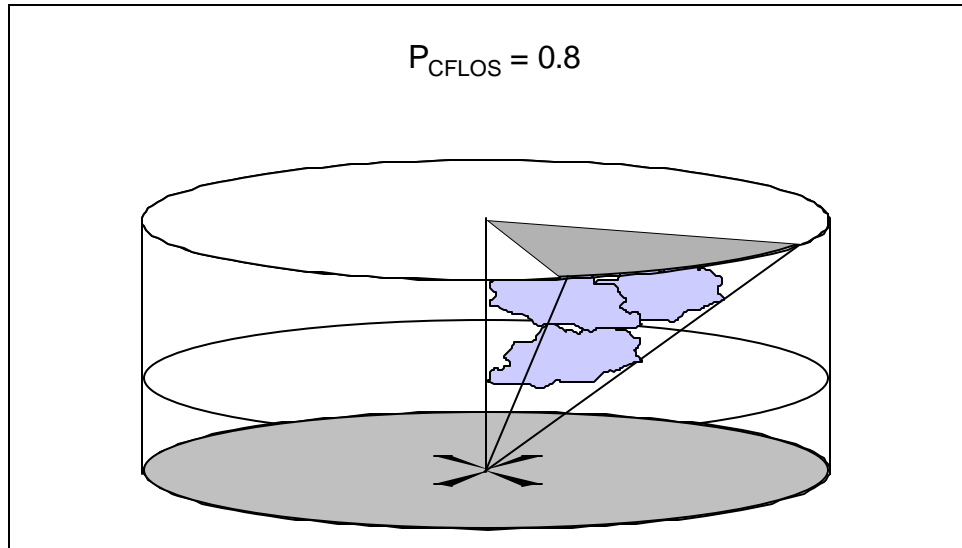

Figure D-5. Notional Cloud Cover Over a Combat Area

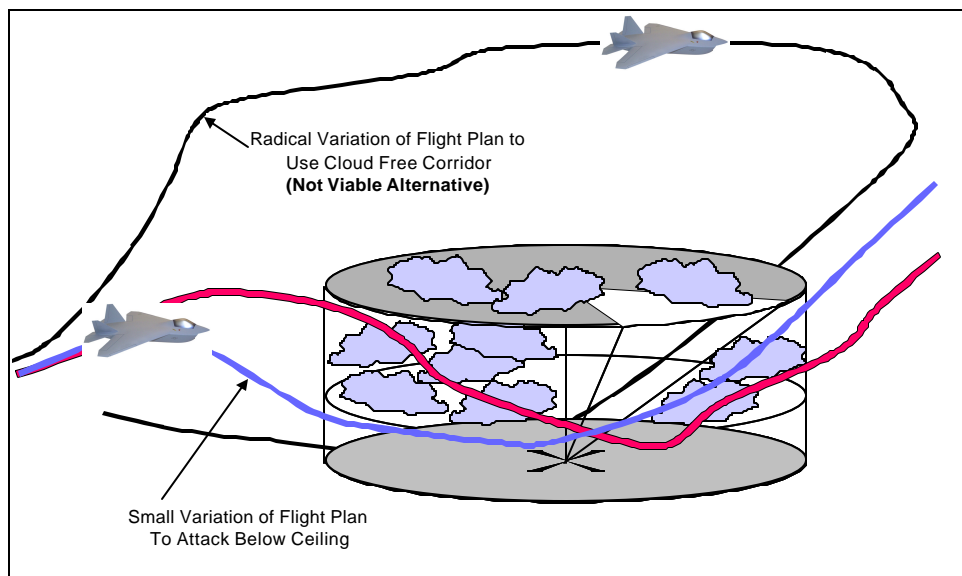

Figure D-6. Flight Plan Variation Under Different Cloud Conditions

When examining conditions of varying cloud cover, the first observation might be to ask how one arrives at operational alternatives. If for example 80 percent cloud cover was expected during the mission planning, the aircrew might have opted for an alternate weapon for that target. In some cases there may have been significant changes in the weather between mission planning and target attack. In other cases the HELs might be the weapon of choice based on availability of other weapons, or on unique requirements (no collateral damage). In these cases the aircrew would be faced by the situation in Figure D-6.

Figure D-6 shows a pre-planned ingress route that will likely result in cloud cover over the lasing path between aircraft and target. In this case, the aircrew would need to take some other action to successfully prosecute the target. One alternative tactic would be to dive down below the cloud deck and conduct the HEL attack at a lower altitude, as shown by the grey flight path in Figure D-6. From a weather perspective, this can usually be accomplished since the clouds typically form at some minimum altitude (6,000 ft. or higher). From a safety and survivability perspective, this may not be viable depending upon terrain (mountains) and low altitude threats (AAA and man-portable air defense systems).

Another tactic would be to make a wide sweep around the target area and attack the target through the cloud free corridor (shown as the black flight path in Figure D-6). This would not present the same risks based on terrain and threats, but would be more difficult to fly within the context of an air tasking order involving other allied aircraft and coordination with ground forces. The black flight profile would be difficult to re-plan on the fly, and would cause the aircraft to miss its time-on-target, presenting risks of fratricide to itself and other allied forces. For these reasons, the black flight profile is generally not viewed as viable.

Advanced avionics systems could aid the aircrew in understanding the current weather situation thereby increasing the likelihood of success in altering the flight profile as shown in Figure D-6. The ability to instantaneously view the weather situation at the target area, while still en route, could greatly enhance an aircrew's ability to successfully complete a mission. If for example, the aircrew could recognize the current cloud cover situation in Figure D-6 well before approaching the target area, they might be able to make flight path adjustments to be on the desired black flight path, and still make the proper time-on-target for coordination with other friendly assets. The more highly this could be integrated with other avionics, the better the potential utility. In the previous example it was assumed that the aircrew would recognize the current weather state while still en route. If this information could be integrated with other data such as threat locations, other friendly aircraft, and mission plans, a more effective and survivable flight path would result.

The effect of weather on HEL fighter operations can now be summarized in Figure D-7. In the pie chart on the left (representing $P_{CFLOS} = 0.2$), the cloud free region would be acceptable for HEL operations. The dark gray area would not be immediately usable for HEL operations because of cloud coverage. If, however, advanced avionics were implemented, some of this clouded area might be recoverable. The arrow leading to the pie chart on the right illustrates this. The supposition would be that the light gray sub-segment, of the area that was previously dark colored gray, might be acceptable for HEL operations with the use of advanced avionics and tactics. This would mean that all but the dark gray

region on the right hand pie chart represent the total amount of battle space where the HEL would be effective.

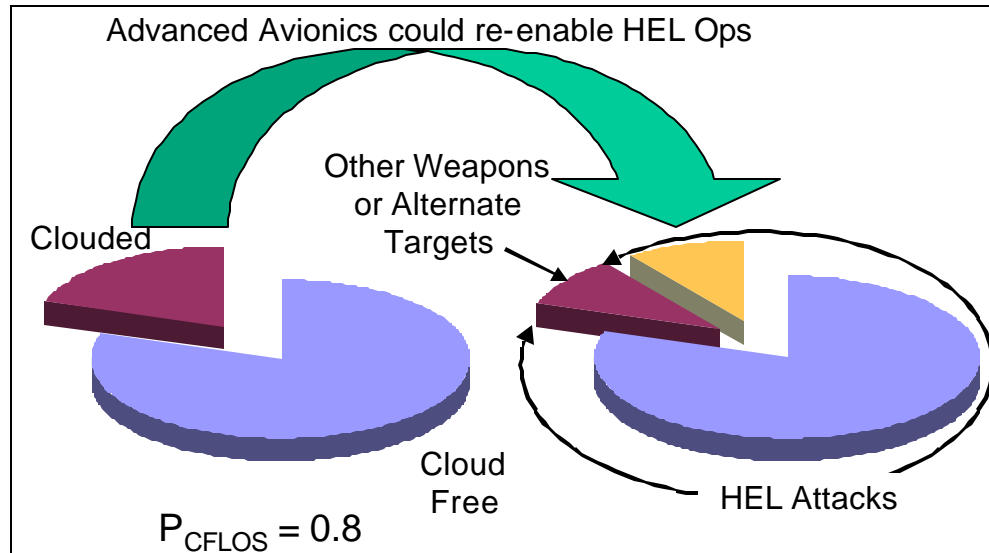

Figure D-7. Effect of Weather on HEL Operations

Turbulence: Difference A-A and A-G Missions

Turbulence in Tactical HEL Fighter engagements is of two types. The first is clear-air turbulence caused by incomplete mixing of thermal layers near the ground resulting in velocity, density, and refractive index perturbations along the laser path. The second effect is aerodynamically induced turbulence in the aircraft boundary layer. This is caused by high-speed airflow over the fuselage and beam director. The sources and effects of turbulence are illustrated in Figure D-8.

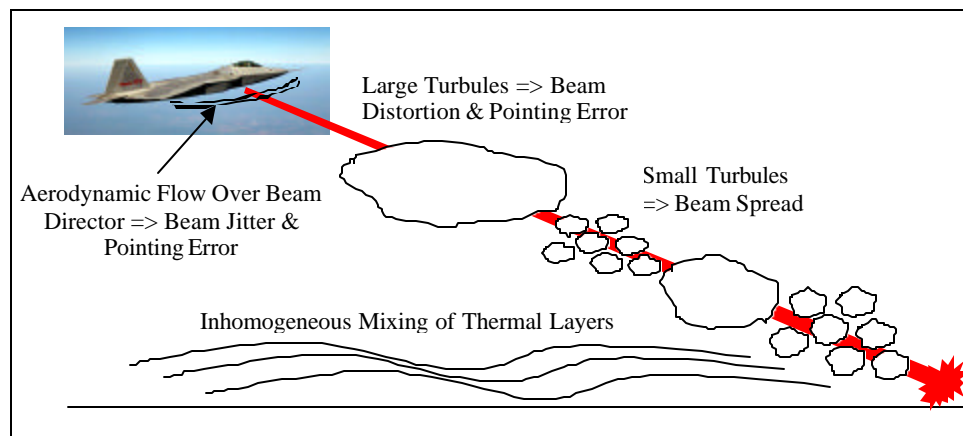

Figure D-8. Sources of Turbulence and Effects on Beam Propagation

The spatial and temporal frequencies characterizing clear air and aerodynamic turbulence vary as a function of system configuration and operations. Parameters include aircraft shape, size, speed, and altitude; laser wavelength, beam quality, and beam diameter; and operating time-of-day and season. However, the effects of the two sources on propagation are similar. They include: (1) beam steering due to large scale phase errors which is most sensitive to turbulence near the source (e.g., laser transmitter); (2) beam spread, similar to wide angle scatter, due to small scale phase errors; (3) degradation in spatial coherence; and (4) scintillation due to interference effects over the coherent wave front.

ADDENDUM: CLOUD DESCRIPTIONS

A cloud is a visible mass of minute water droplets or ice particles suspended in the atmosphere. Fog is basically a cloud that reaches the surface of the earth and is a direct expression of the physical processes that are taking place in the atmosphere. In order to produce a cloud three conditions must be met: sufficient moisture must be present, some sort of lifting (or cooling) mechanism, and condensation or sublimation nuclei to initiate the process. There have been international agreements on cloud classification; a convention accepted by most countries around the world. The importance of an international classification of clouds cannot be overestimated, since it tends to make cloud observations standard throughout the world.

Clouds have been divided into etageres, genera, species, and varieties. This classification system is based primarily on the mechanisms that produce clouds. Although clouds are continually in a process of development and dissipation, many have distinctive features that make classification possible. Genera clouds are

- CIRRUS (CI) - Thin feather-like clouds.
- CIRROCUMULUS (CC) - Thin cotton or flake-like clouds.
- CIRROSTRATUS (CS) - Very thin, sheet cloud.
- ALTOCUMULUS (AC) - Sheep-back like clouds.
- ALTOSTRATUS (AS) - Highly uniform sheet cloud.
- NIMBOSTRATUS (NS) - Dark, threatening rain cloud.
- STRATOCUMULUS (SC) - Globular masses or rolls.
- STRATUS (ST) - Low uniform sheet cloud.
- CUMULUS (CU) - Dense dome-shaped puffy looking clouds.

- CUMULONIMBUS (CB) - Cauliflower towering clouds with cirrus veils on top.

MISSION IMPACT

It is convenient to divide cloud impacts on tactical aircraft missions into two separate categories: impacts on air-to-air missions and impacts on air-to-ground missions. It is now possible estimate which clouds etageres might affect the prosecution of these two distinct missions. For example, high clouds would generally be of no concern to the application of a tactical laser in a close air support scenario, but might be in the en route escort of a high-value airborne asset. First, a few of the possible missions affected by low clouds are highlighted.

<u>Low Cloud Types</u>	<u>Droplet size</u>	<u>Possible Missions Affected</u>
Stratus	100m - 1mm	Close Air Support (CAS) Offensive Counter Air (OCA)
Stratocumulus	1mm +	RECCE / CSAR, Strategic Attack
Nimbostratus	~ 1mm +	Air Interdiction Mine Warfare
Cumulus	10mm - cm	CAP / TAC (A)

All of the above cloud types are optically opaque in their normal state. The time of year and location will generally determine cloud content—that is, if the clouds are composed of water droplets and/or snow and ice crystals. There are, however times when the absolute humidity present may be minimal in some stratus clouds. This condition results in an optically and physically "thin" cloud, regardless of what the surface reports may indicate. (Note: A ceiling layer of 6/10ths or greater sky coverage may be reported indicating a broken to overcast sky condition, but the cloud in this case would not be optically opaque). These "thin" ceiling layers allow the warfighter to see through the cloud, and therefore would allow the possibility of employing a tactical laser. Stratocumulus clouds often present a cellular appearance with breaks in the overcast where there may be opportunities to use a tactical laser in the holes between the clouds. As mentioned previously, stratocumulus clouds are not very "thick" and do not have a large vertical extent.

The next chart shows the effects middle clouds may have in the prosecution of different missions.

<u>Middle Cloud Types</u>	<u>Droplet size</u>	<u>Possible Missions Affected</u>
Altostratus	10m - 100m	TBM Intercept
Alto cumulus	1mm +	Large A/C Self Protect
Nimbostratus	~ 1mm +	Small A/C Self Protect
Cumulus	10mm - cm	High Value "Escort"
Cumulonimbus	10mm - cm+	Close Air Support

All of the above cloud types are optically opaque in their normal state. Again, the time of year and location will generally determine cloud content. Cumulus and Cumulonimbus clouds contain by far the largest sized water droplets (in reference to diameter) and also the greatest amount of total water vapor content. They are always optically opaque. There are, however occasions that the absolute humidity present may be minimal in some altostratus clouds. As in the case of stratus clouds, this would result in an optically and physically "thin" cloud, regardless of what the surface reports may indicate. It is possible to see through these "thin" cloud layers and would again allow the possibility of employing a tactical laser. Alto cumulus clouds present a cellular appearance with breaks in between each cell, so there may be opportunities to use a tactical laser in the holes between the clouds. As mentioned previously, alto cumulus clouds are not very "thick" and do not have a large vertical extent.

Finally, the effects of high clouds should have the least direct impact on the application of a tactically sized laser mounted on a fighter aircraft and these are listed below.

<u>High Cloud Types</u>	<u>Droplet size</u>	<u>Possible Missions Affected</u>
Cirrus	100m - 1mm	TBM Intercept
Cirrostratus	100m - 1mm	Large A/C Self Protect
Cirrocumulus	1mm +	Small A/C Self Protect
Cumulus	10mm - cm	High Value "Escort"
Cumulonimbus	10mm - cm+	Offensive Counter Air RECCE, CAP / TAC (A)

With this brief discussion of the nature of clouds, it is now apparent that the distribution of clouds in the tactical engagement arena must be established for the warfighter to successfully employ HEL weapons. To determine the cloud distribution, the databases for historical cloud cover must be described. These databases must be coupled with the meteorologist's ability to predict cloud coverage and location necessary to employ "tactical" high-energy lasers.

CLOUD DATABASE STRUCTURE AND DISTRIBUTION

The primary purpose for encoding and transmitting weather conditions occurring at and above a specific location on the surface of the earth has been in support of aviation. Current weather conditions are necessary information to a pilot during the critical phases of flight, including take-off and landing. As the acquiring and recording of surface observations expanded over the years, emphasis remained in highlighting the safety of flights. Safety issues include obstructions to visibility which would result in in-flight visibility of less than 7 miles; cloud bases located below 3,000 feet; wind direction, speed, and gust characteristics which would affect the active runway(s); surface temperature; and any precipitation which might be occurring. It is here where the cloud database may not be totally representative of what is actually there.

By convention, cloud layers are summed using a principle called "at and below." This means that one would add cloud layer coverage, starting from the surface and continuing upward until an overcast condition is reached (> 9/10ths coverage). For example, starting with the 6/10ths of stratocumulus at the 3,000 foot level, one next adds the 4/10ths of altocumulus clouds with bases at 10,000 feet to arrive at a total cloud coverage of 10/10ths: an overcast sky condition. If one were to reconstruct the cloud history of the above example location, the database would reflect a complete sky cover based at 10,000 feet. First impressions would suggest that with a complete overcast, a laser operating on a tactical aircraft could not be effective because of clouds. However, the description of stratocumulus and altocumulus clouds coupled with the conservative bias in cloud record keeping showed there would be plenty of opportunity to operate in and around the clouds in this example. Figure D-9 illustrates this erroneous conclusion.

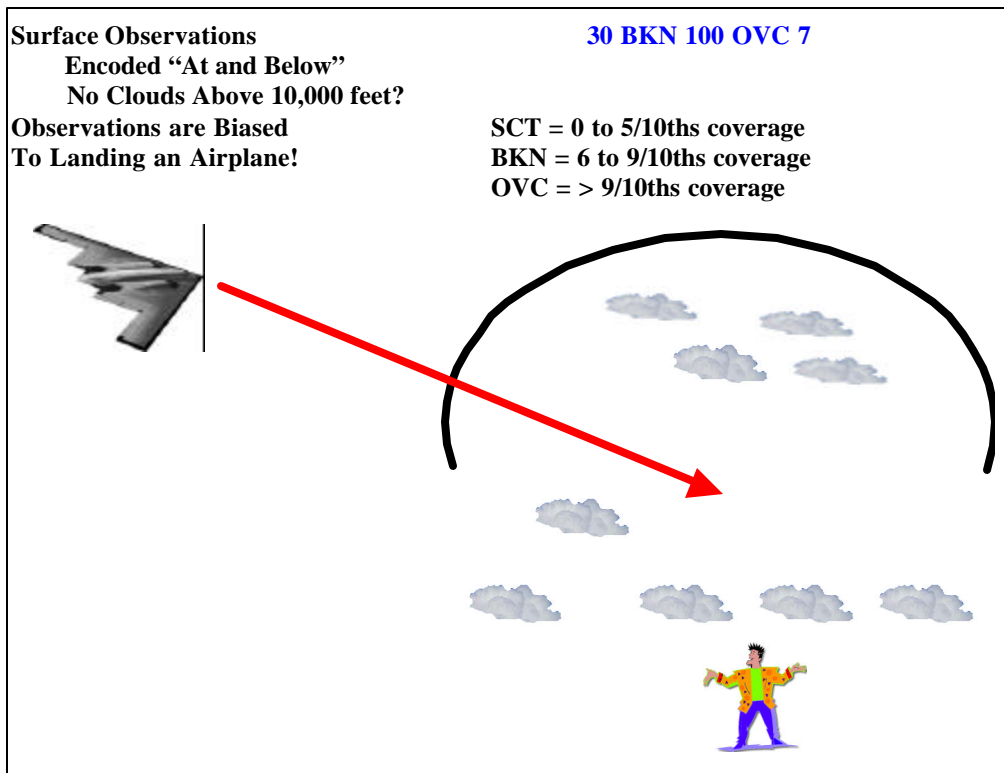

Figure D-9. Tactical HEL Operations are Possible with Some Cloud Cover

This is just one of many scenarios that could be reconstructed supporting the utility of high-energy laser application on a tactical fighter platform. Since "holes" in the clouds (cloud-free arcs) may be available for exploitation, a methodology to identify the location of cloud-free arcs must be found. Mathematical modeling offers the most promising approach at this time.

Increased predictive capability will assist in providing two important items. The first, and possibly the most critical item, is to identify if there will be any available cloud-free arcs of which to take advantage. If one can identify the fact that there will be opportunities available to both use cloud-cover to mask fighters while exploiting available cloud-free arcs to the target, the result will be a much higher percentage of employment opportunity for using a tactical high-energy laser. The second item is to identify where the clouds are and will be during operations. As previously stated, it is difficult to believe state-of-the-art weather prediction will ever advance to the point where the atmosphere will act in a completely deterministic manner. However, these shortfalls can be augmented with a combination of off-board sensors, real-time information transfer into the cockpit, and the development of appropriate concepts of operation.

In the future, off-board sensors will likely be used to collect, process, edit, and then forward critical operational information concerning en route and "area of operations" environmental conditions directly into the cockpit. This battlefield intelligence will aid in expanding the operational envelope for use of a tactical high-energy laser.

With today's rapid advances in computing, remote sensing, and communications technology, there should be definite operational utility in fielding a tactically sized, high-energy laser on board a fighter aircraft. Weather support should be viewed as an emerging, enabling technology. It will provide environmental data support that will enhance the opportunity to reclaim a portion of the battle space currently under used by the warfighter. Increased capability in modeling atmospheric processes will allow the meteorologist to produce artificial data that will define the operational battle space to a level of detail previously unknown. The increased speed of computer processing should allow incorporation of real-time weather forecasting products, generated at a rate that is "inside" the current air tasking order cycle.

The last step of the evolution will come about by the integration of off-board sensor technology. Advanced head-up displays should be able to provide to the aircrews in the cockpit real-time visualization of the current environmental status of the battle space. The combination of advanced computing, sensor, and laser technology, combined with next generation environmental assessment and prediction techniques, should allow the tactical high-energy laser fighter to become a cornerstone of the warfighter's arsenal.

PROBABILITY OF CLOUD-FREE LINE-OF-SIGHT: "STATISTICAL"

Clouds can have a major impact on performance and mission opportunity of airborne laser weapons. Database summaries and modeling techniques are presented for the physical and optical characteristics of low- and mid-level clouds expected in Tactical HEL Fighter missions. This is followed by a practical, validated method for estimating probability of cloud-free line-of-sight (P_{CFLOS}) as a function of elevation angle. The results are based on site-specific meteorological parameters recorded at three locations of interest. Operational requirements and approaches to reclaim losses in clear line-of-sight Tactical HEL Fighter operations are also described.

Cloud cover is defined as the fraction of the sky that is cloudy when viewed vertically, either upward or downward. It represents the fraction of the area masked from view when the clouds are projected directly onto the ground. This is shown in Figure D-10. Cloud cover varies from 0 to unity. The fractional cloud coverage (C) increases as a function of

increasing zenith angle, or conversely, decreasing elevation angle due to the vertical extent of the clouds and increasing optical depth for a given extinction coefficient. The variation in C with zenith angle is sometimes referred to as *apparent cloud cover* (S). It can be seen that $S \geq C$ with $S = C$ at zenith. The probability of cloud-free line-of-sight, or P_{CFLOS} , is defined as the complement of S , that is, $P_{CFLOS} = 1 - S$. This is shown in Figure D-11.

The Lund Algorithm method is used to calculate probability of cloud-free line-of-sight or P_{CFLOS} . The approach has been shown to agree well with measurements when an observer is on the ground, looking above the horizon at various elevation angles. Although the Tactical HEL Fighter geometry is different (observer or transmitter at altitude looking down), the Lund approach is still valid because of reciprocity. P_{CFLOS} is independent of direction along the line-of-sight for a given elevation or zenith angle.

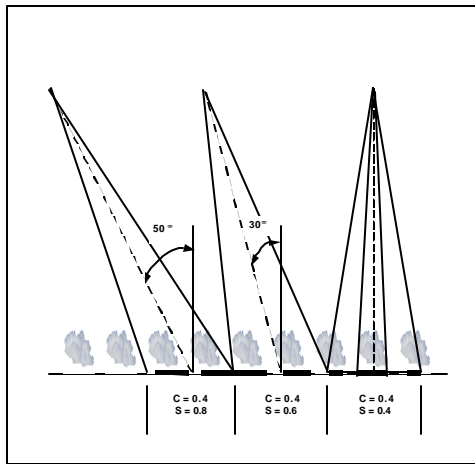

Figure D-10. Cloud Cover Nomenclature

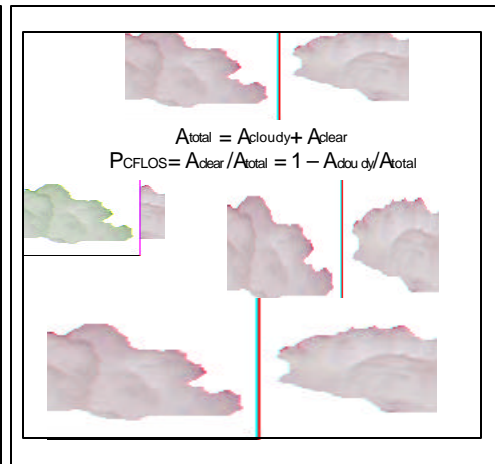

Figure D-11. P_{CFLOS} Terminology

Initially, it might be concluded that the low summer P_{CFLOS} in the Western Pacific (like Korea) would severely limit the effectiveness of tactical HEL aircraft operations. However, closer examination of the characteristics of the three-dimensional cloud structure and aircraft performance shows that aircraft operations can be modified to regain some losses in line-of-sight. For instance, the probability of HEL kill should be conditioned by the reduced performance of the target's guidance system (such as FLIR) and lower probability of Tactical HEL Fighter detection in limited visibility. In other words, the electro-optical missile guidance and HEL systems are *both* subject to the same environmental constraints.

Figures D-12 and D-13 illustrate potential operating approaches in typical engagements involving cloud cover. In Figure D-12, the Tactical HEL Fighter pilot and weapons officer(s) are assumed to have the benefit of: (a) real-time knowledge of local cloud cover, including automated off-board and organic sensor data fusion and decision aids; (b) high aircraft speed and maneuverability; and (c) precise target tracking and beam pointing. The objective is to locate patches of sufficient cloud-free arc and adjust aircraft altitude and speed to satisfy required dwell time. Figure D-13 shows how the aircraft might operate in overcast or low P_{CFLOS} conditions. In this case, a relatively clear line-of-sight is expected below the ceiling, but at risk of a greater exposure to anti-aircraft defenses.

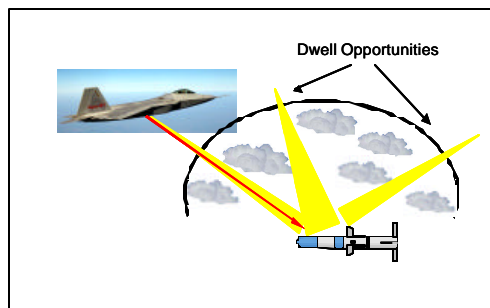

Figure D-12. Engagement Where Tactical HEL Aircraft Exploits Regions of Moderate to High P_{CFLOS} and Cloud-Free Arc

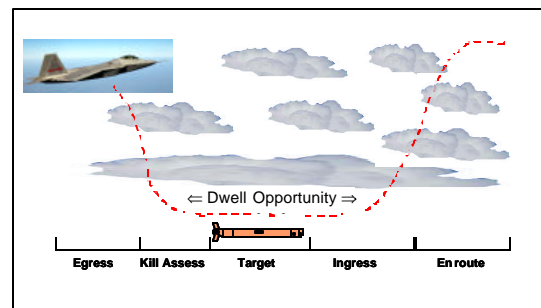

Figure D-13. Engagement Where Tactical HEL Aircraft Exploits Low P_{CFLOS} and Moderate Cloud Ceiling

The approaches illustrated in Figures D-12 and D-13 show that the probability of cloud-free arc (P_{CFA}) or probability of cloudy arc (P_{CA}) and P_{CFLOS} are required to generate accurate cloud realizations for a given site to assist mission planning. This is because P_{CFLOS} , by itself, is not unique. Figure D-14 shows two cloud scenes that have equal sky cover and P_{CFLOS} over a given field-of-view, but different P_{CFA} and P_{CA} . The P_{CFA} for *continuous* arc lengths in Figure D-14 may be too small for the required HEL dwell time. However, the *cumulative* cloud free arc may be sufficient to satisfy the damage threshold. In contrast, Figure D-14 may have sufficient probability of a single, large continuous arc to accomplish all phases of engagement without interruption. This represents a “best case” condition. Each cloud cover state requires a different approach to aircraft operations.

One of the most important enabling technologies will be heads-up-display information of cloud distribution and P_{CFLOS} accurately displayed for specific GPS coordinates pre-determined by the sortie mission.

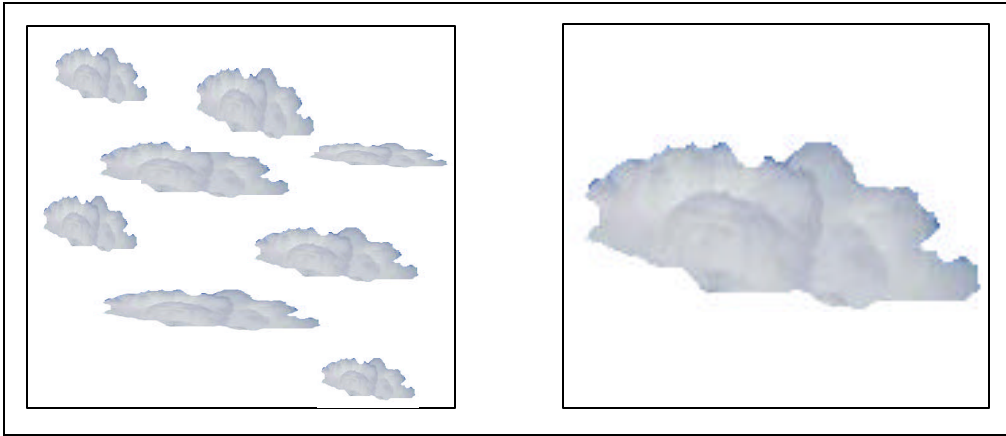

Figure D-14. Two cloud realization scenes with equal P_{CFLOS} and field of views but different P_{CFA} .

**APPENDIX E. FREE ELECTRON
LASERS**

This appendix discusses two development approaches for free-electron lasers that can be used in military applications. The first is research conducted by the Thomas Jefferson National Accelerator Facility (Jefferson Laboratory) and the second by Los Alamos National Laboratory.

JEFFERSON LABORATORY FREE-ELECTRON LASER SYSTEM

The Department of Energy's Thomas Jefferson National Accelerator Facility has developed under Navy, DoE, Commonwealth of Virginia, and industrial funding a high average power free-electron laser (FEL) system which can provide 2 KW of tunable infrared (IR) radiation as a quasi-continuous series of picosecond pulses.^{E-1} As the highest average power short pulse laser in the world and the only such laser that is tunable over a wide range of the infrared, the device is presently in use for scientific and applied commercial and DoD research.

Significant results have already been achieved in the areas of micro machining, plasma vapor deposition, energy flow in biomolecules, and defect energetics in silicon. The FEL is a completely unique technology whose lasing technique, wavelengths, and operating modalities depart so significantly from other solid state, chemical, and diode technologies that analogous effects, inferences, and extrapolations based on non-FEL systems observations are problematic. The technology on which this laser is based, superconducting radio-frequency (SRF) accelerators, lends itself to a natural capability toward efficient operation and long run times at higher powers.

A layout of the system is shown in Figure E-1. The key feature to note is the use of an energy recovery loop for the electron beam which recycles the remaining electron energy. Significant reductions in electrical power, installed RF generation, and radiation production result and lead to significant cost savings for large scale devices, as Figure E-2 later illustrates.

SCALING TO HIGHER LEVELS OF POWER

Studies at Jefferson Lab have indicated that scaling the system to produce 100 KW of power in the 1-micron spectral region is

^{E-1} This appendix summarizes the Jefferson Laboratory presentation to the Defense Science Board High Energy Laser task force (January 25, 2001).

straightforward with modest improvements required in injector and resonator optics technology. Powers higher than this can be contemplated in the next decade by applying relatively modest research and development efforts. Congressionally directed funding is already being applied by the Office of Naval Research (ONR) to extend the performance of the JLab FEL to 10 KW in the IR. In addition to a laser technology demonstration, the JLab FEL is useful for the study of short pulse IR damage effects on materials and IR sensors. Funding is expected under U.S. Air Force auspices to establish kilowatt levels of ultraviolet production for micro-machining nano-satellite components.

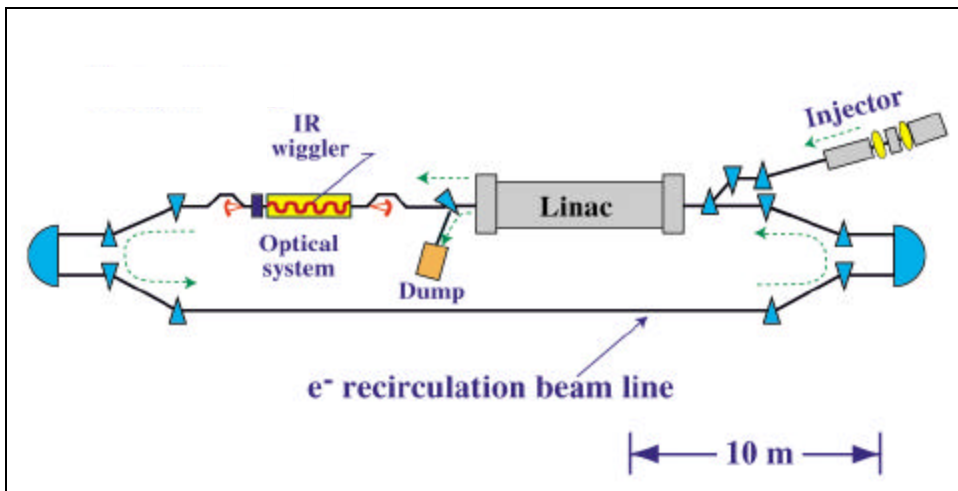

Figure E-1. A layout of the Jefferson Lab FEL

The High Energy Laser Master Plan (HELMP) recommends ***“DoD should implement a new management structure for HEL technologies.”*** This includes designation of the Navy as the ***“Technology Area Working Group (TAWG) Lead”*** responsible for ***“...developing [a] detailed [FEL] technology roadmaps.”*** Continued Department of the Navy investment in the JLab demonstration FEL is therefore justified. It is encouraged by both the HELMP recommendations and the low risk, high payoff S&T results that will likely result from leveraging JLab’s continuing efforts and successes to date.

Since JLab is presently funded to develop components for a 10 KW FEL, the lab is in a unique position to develop and test extensions that will permit scaling that output to the 100 KW level and beyond. The HELMP recommends: ***“DoD should stimulate the HEL supplier base with a few focused investments.”*** Specifically, under ***“Free Electron Lasers”*** the number one HELMP roadmap priority is the development of ***“...High Power Injectors,”*** the number two HELMP roadmap priority is investment in the development of ***“...High Power Resonators/Undulators,”*** and the

number three HELMP roadmap priority is investment in the development of “...*High Average Current Electron Beam Transport*”.

All of these systems are being addressed to some extent by the JLab FEL effort. However, no focused effort in any of these areas is presently funded but is required to achieve the next level of capability in performance. Jefferson Lab is poised to continue such development as directed and to apply such new capabilities for dual use applications as well as DoD needs.

SCIENCE AND TECHNOLOGY NEEDS

Figure E-2 shows the expected performance improvements as the FEL power is scaled up utilizing JLab technology versus a more conventional approach. The dramatic impact of adding energy recovery to a system is shown in this comparison. The real wall plug to light efficiency is shown as a function of electron beam to light extraction efficiency. For the practical performance of 3 to 8 percent electron beam energy to light, over a factor of 3 to 4 improvement is realized in wall plug to output efficiency.

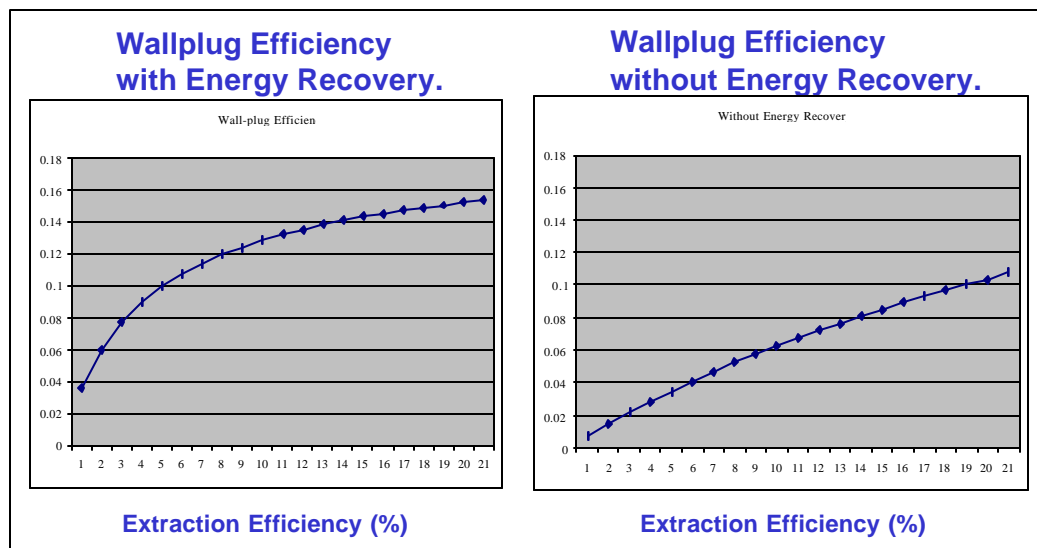

Figure E-2. Impact of Energy Recovery on FEL Performance

The March 2000 High Average Power Free Electron Laser Technology Assessment Report to the High Energy Laser Executive Review Panel, identified a number of physics/technology issues and engineering issues that must be resolved before a MW class FEL becomes a reality. This list includes:

1. Develop ampere level average current injectors with good electron beam quality.
2. Develop resonators and high flux optics and coatings (>100 KW/cm² incident).
3. Develop high power superconducting RF accelerator components (windows, absorbers, tuners).
4. Develop techniques to focus and bend, without spill, high current beams with energy spread.
5. Develop compact reliable 4°K cryogenic systems.
6. Develop passive and active alignment and control systems to counter system flexing, vibration, and induced microphonics in a non-laboratory environment.
7. Develop higher-gradient (> 12 MV/m) RF linear accelerators capable of handling multi-nanocoulomb electron bunches and amp level average currents.
8. Demonstrate effective energy recovery with modest efficiency (1 - 2%) wiggler extraction.
9. Integrate and demonstrate that all the subsystems, acting together, perform as expected.

It is significant that the Jefferson Lab Program is addressing the majority of these items while performing its upgrade to 10 KW in average power, as described below.

Issue 1. The injector is recognized as the key technological development required for scaling to higher powers. *The existing injector at JLab is the highest average brightness injector in the world.* It is presently undergoing upgrades that will more than double its capacity. To achieve the 100 KW output level desired, it will be necessary to increase the brightness an additional factor of 5 to 10. The original Jefferson Lab design chose to address the physics scaling issues up front and resolved them at low power. Adding power supplies to the system will be the only requirement for the next level of performance.

This is illustrated in Figures E-3 and E-4 where the peak and average brightness of the Upgrade injector is compared to the requirement for 100 KW. Going to this higher performance involves increasing the high voltage power supply (a commercially available component), and the RF power to the first superconducting cavities (again, these components are commercially available). To scale beyond this level will likely require lowering the RF drive frequency but such technology exists or is being developed by Jefferson Lab for other DOE programs such as the

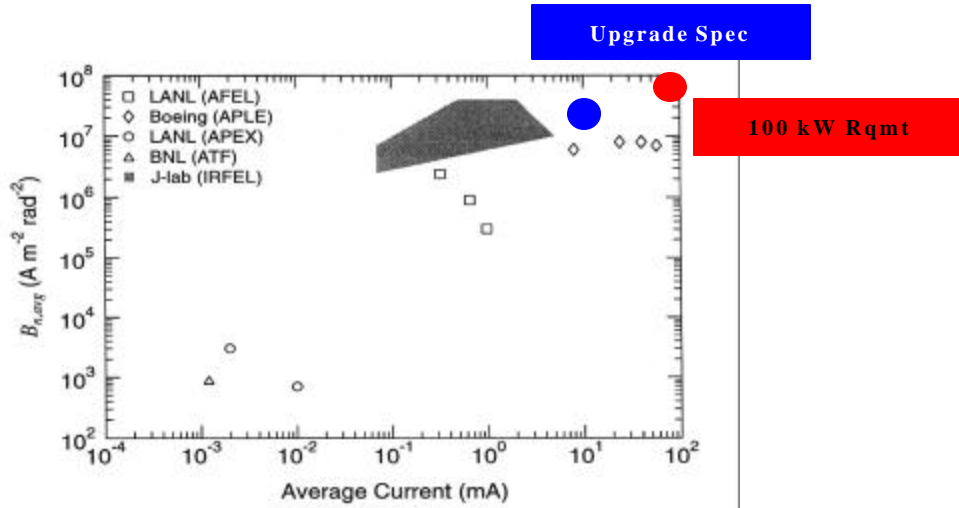

Figure E-3. Average brightness achieved from a number of FEL injectors²

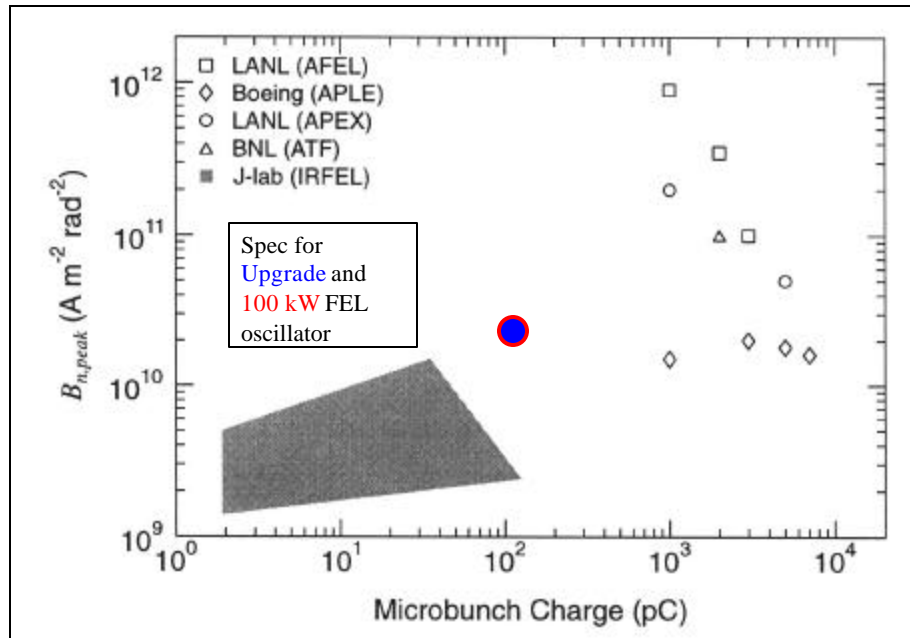

Figure E-4. The peak brightness of existing injectors and requirements for oscillator³

² After D. Nguyen, LANL. Jefferson Lab has added the Upgrade specification and the planned 100 KW requirement.

³ After D. Nguyen, LANL. We have modified the drawing to include our planned Upgrade specification and the 100 KW FEL requirement. Note the injector requirements for the 10 KW oscillator approach meets the Upgrade requirements. This means no new physics issues are introduced into the design.

Spallation Neutron Source (SNS) thus addressing Issue 3 of the High Energy Laser Executive Review Panel.

Issue 2. The second major technology hurdle is the high power optical resonator. This is also being developed in the Jefferson Lab Programs. Recent analyses have concluded that the optical resonator for the IR Upgrade system can be made to operate under presently demonstrated performance levels (65 KW intracavity). It is unlikely that significant further increases in output can be achieved without some level of performance improvement so work is also proceeding at JLab on advanced resonator designs. The JLab UV FEL Program requires such technology and will develop it under Air Force funding.

Issue 3. It was already mentioned that the development of low frequency high power cavities for the SNS provides a synergistic technology development path for high power superconducting RF accelerator components. The SNS is a major DOE facility with significant resources being applied. It is expected that such systems will be technologically mature well in advance of a DoD need. Substantial progress has been made in this area in the last several years and a number of major physics facilities are envisioned to utilize compatible technology. The FEL community is expected to benefit in cost and performance as gradient increases from the recent 12 MV/m to newly achieved levels of 35 MV/m and more.

Issue 4. JLab made important strides last year in developing the means to transport high current electron beams and recover their energy—an achievement that is recognized outside the FEL community. As a result, a number of new accelerators, in the planning stages, will utilize the energy recovery technology demonstrated on the JLab FEL. Several national laboratories are now collaborating with Jefferson Lab for the application of this technology to high power particle accelerators. It is believed that the electron transport system presently under construction for the JLab Upgrade will suffice for FEL power outputs beyond 100 KW.

Issues 5-9. Similarly, other technologies (cryogenics, control technologies, higher gradient cavities, energy recovery, and overall system integration) are being addressed as part of the ongoing program. While there are no guarantees, it seems that development to the 100 KW level is not likely to meet any hard limits.

Ongoing FEL programs at Jefferson Laboratory address a large fraction of the issues associated with scaling the FEL. Furthermore the synergistic benefits from other DOE programs in the areas of injectors, energy recovery, high current transport, and high power superconducting accelerators will be substantial and present high leverage for future DoD investments in this technical approach.

REFERENCES

- S.V. Benson et al., "Jefferson Lab Free-Electron Laser Starts Operation with Sustained Lasing at the Kilowatt Level," *Synchrotron Radiation News*, Vol. 13 (4) (July/August 2000) 13.
- G. R. Neil et al, "Sustained Kilowatt Lasing in a Free-Electron Laser with Same-Cell Energy Recovery," *Phys. Rev. Letter* 84(4), (2000) 662-665.
- M. Shinn, "High Power Free-Electron Lasers - A New Laser Source for Materials Processing," *SPIE Vol. 4065*, (2000) 434-440.
- H. F. Dylla et al., "Applications of the Jefferson Lab Free Electron Laser for Photobiology," *SPIE Vol. 3925* (2000) 40-49.
- G. R. Neil, and H. F. Dylla, "The Jefferson Laboratory High Power Free Electron Laser." Presented at the 2nd Annual Directed Energy Symposium, Kirtland, AFB, NM, November 1-5, 2000.

SUMMARY OF THE LOS ALAMOS REGENERATIVE AMPLIFIER FEL TECHNOLOGY

INTRODUCTION

The free-electron laser holds the promise of an all-electric megawatt-power laser weapon with high optical quality that consumes only water and electricity, therefore requiring a simple logistical trail. The FEL produces a wavelength-adjustable output with flexible pulse formats to induce a range of effects on the targets from denial to destruction. Nevertheless, up to now many FELs have been designed using physically large accelerators and damage-prone optical resonators that are not suitable for field deployment. Within the past three years, a novel FEL design has been developed at the Department of Energy National Nuclear Security Administration's Los Alamos National Laboratory based on the high-gain Regenerative Amplifier concept, illustrated in Figure E-5. This new FEL can be made very compact and rugged, and at the kilowatt power level, is small enough to be portable. At the megawatt level the Regenerative Amplifier FEL can be deployed on a mobile platform such as a modern electric drive naval ship.

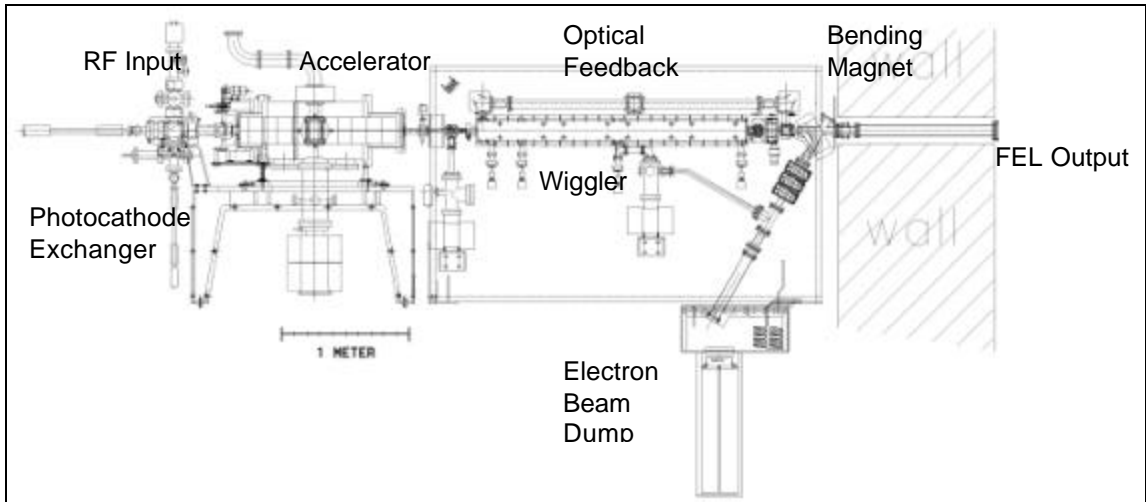

Figure E-5. Schematic of the high-gain Regenerative Amplifier FEL at Los Alamos National Laboratory.

REGENERATIVE AMPLIFIER FEL TECHNOLOGY

Los Alamos has a long history of high-power oscillator FEL development dating back to the SDI era. Although the SDI efforts did not produce high average power, the basic physics of the radio-frequency linear-accelerator-driven FEL for high average power systems has been studied extensively. Much of the oscillator FEL physics is well understood. In addition, a number of advanced technologies such as high-brightness electron injectors and grazing incidence optical resonators have been demonstrated during this program. From the lessons learned with high-power oscillator FEL development, Los Alamos has moved away from the oscillator design, principally because the oscillator FEL presents a rather long list of issues whose resolutions depend on electron beam physics and optical engineering that are still underdeveloped. Los Alamos has since developed a novel FEL design based on a high-gain amplifier that we call the Regenerative Amplifier FEL (RAFEL). The new FEL design presents a few issues that can be solved with existing engineering practices. More importantly, the RAFEL design resolves some of the most difficult issues associated with the oscillator FEL design. These problems—optical damage, sensitivity to vibration and misalignment, and extraction efficiency—will be discussed in detail below.

Optical Damage

The first issue the RAFEL design resolves is optical damage to the resonator mirrors, a serious problem in the oscillator FEL design because the optical power inside the resonator is typically ten times higher than the FEL power. The RAFEL key idea is to use a low-Q optical resonator—one that allows most of the power to exit and stores a small fraction of the

output power—to re-inject less than 10% of the generated power back into an exponential-gain amplifier. The large single-pass amplification ratio (between a few hundred and a few thousand) amplifies the low-level optical feedback to a very high power level at the exit of the high-gain wiggler amplifier. After a few passes, the FEL power reaches a maximum power level—that is, it saturates. The large amplification ratios are possible thanks to the use of high-brightness electron beams—that is, electron beams with high peak current, low transverse spread and high monochromaticity—and a specially designed wiggler that continuously focuses the electron beam in both transverse dimensions throughout the wiggler length.

The present design of the low-Q resonator consists of two flat mirrors and two curved mirrors shown in Figure E-6. The right-hand-side flat mirror has a one-centimeter-diameter hole through which most of the FEL power exits. This annular mirror captures only a ring of light on the outer edges of the gaussian laser beam and the two curved mirrors at the top re-image the low-power light back to the entrance of the wiggler amplifier. Because most of the FEL power exits the resonator, the power inside the low-Q resonator is one-tenth the output power. This large reduction in optical power inside the low-Q resonator means the mirrors are subject to much less optical intensity and they are much less prone to optical damage. The use of low-power feedback also means that the low-Q resonator mirrors can be made out of simple metals (e.g. copper) that do not need to have very high reflectivity.

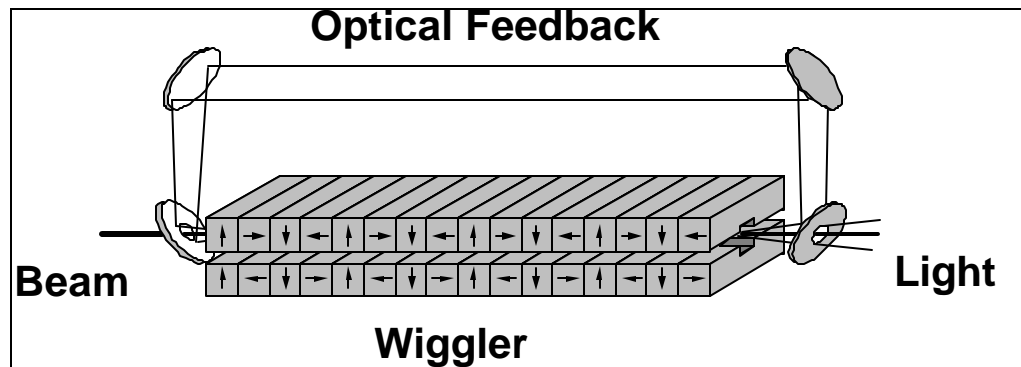

Figure E-6. Illustration of the RAFEL Idea.

The optical feedback loop consists of two annular mirrors and two curved mirrors. The electron beam enters the high-gain wiggler from the left through a small hole in the upstream mirror. The FEL beam exits the feedback cavity through a large hole in the downstream annular mirror.

Sensitivity to Vibration and Misalignment

The output of a radio-frequency linear-accelerator driven FEL is a train of pulses a few picoseconds in duration. In a low-gain oscillator FEL, these picosecond pulses have to be overlapped in time with the

picosecond electron pulses over thousands of passes needed to reach maximum power. Consequently, the resonator length must be aligned to an accuracy of a few microns and the angular alignment of the mirrors to a few microradians. In the new high-gain RAFEL, the combination of very large single-pass amplification ratios (between a few hundred and a few thousand) and a small optical feedback enables the FEL to saturate in a few passes. The optical pulses only need to overlap with the electron pulses over the picosecond duration, and the low-Q resonator only has to be aligned to an accuracy of a few millimeters, instead of a few microns. The large amplification ratio also offers an additional benefit: the electron beam acts like a fiber amplifier and guides the optical beam through the amplifier. Small angular misalignments of the low-Q resonator do not affect the performance of the high-gain FEL because the optical axis is determined not by the low-Q resonator but by the electron beam (the optical beam is automatically aligned to the electron beam). The high-gain RAFEL design is thus rugged toward vibration, microphonics and misalignments.

Extraction Efficiency

The third issue that the RAFEL design can potentially solve is the low extraction efficiency of uniform wigglers—wigglers with constant periods and magnetic fields. The extraction efficiency of a uniform wiggler is inversely proportional to the number of oscillation periods in the wiggler. In a typical oscillator FEL, the number of periods is about 100 and the extraction efficiency is approximately 1%. The extraction efficiency can be increased to 10-15% by tapering the wiggler either in wiggler periods or in magnetic field to maintain the FEL resonance condition as the electron beams lose energy. Using a tapered wiggler however requires very high optical intensity that causes optical damage in an oscillator FEL. In the RAFEL design, the large amplification ratio enables the optical beam to reach sufficiently high intensities inside the tapered wiggler for maximum extraction, and the low-Q resonator allows most of the extracted power to exit as useful power. By extracting 10-15% of the electron beam power, the RAFEL increases the overall system efficiency, reduces the required electron beam power and removes the need for energy recovery (for the megawatt power FEL, energy recovery may be used to reduce the radiation created by the high-energy electron beams). This leads to a smaller and simpler FEL.

HIGH-GAIN FEL AND REGENERATIVE AMPLIFIER FEL DEMONSTRATIONS

The high-gain FEL is being developed as a mirror-less approach to the generation of coherent light in the spectral regions where mirrors do not exist, e.g. x-rays or extreme ultraviolet. Very high single-pass gains were

first observed at millimeter wave (by Lawrence Livermore National Laboratory).⁴ Large simple-pass gains have recently been demonstrated at infrared wavelengths (by Los Alamos⁵ and UCLA/Los Alamos⁶), in the visible (by Argonne and Brookhaven National Laboratories), and at deep ultraviolet wavelengths (by the Deutsches Elektronen-Synchrotron facility). Extraction efficiencies on the order of 5% have been demonstrated with tapered wigglers at Los Alamos in the infrared region,⁷ and 40% extraction efficiency has been measured at Lawrence Livermore National Laboratory in the millimeter wave region (see footnote 4).

The novel Regenerative Amplifier FEL concept has been experimentally demonstrated at Los Alamos at very high peak powers with no evidence of optical damage to the low Q resonator mirrors.⁸ The photoinjector providing electron beams with high peak brightness—peak brightness is necessary for large amplification ratios—to drive the high-gain amplifier has also been developed. New designs of the radio-frequency photoinjector with improved thermal management will achieve the high average current, and thus high average brightness, are being developed at Los Alamos. FEL extraction efficiencies of 5% have been measured with the tapered wiggler amplifiers and simulations using validated codes have predicted efficiencies as high as 13%.⁹ The Regenerative Amplifier FEL approach can be applied to the design of a hundred-kilowatt FEL using well-proven room-temperature radio-frequency linear accelerators, similar to those already in operation at Los Alamos that are now producing a 0.7 megawatt proton beam. Scaling to the megawatt level poses a moderate risk in FEL technology, namely increasing the FEL extraction efficiency to the 10-15%, a moderate risk in developing a room-temperature high-average-current photoinjector and a low risk of engineering the high-average-power radio-frequency linear accelerators. The resolutions to these risks already exist at Los Alamos National Laboratory and can be adopted.

⁴ T. J. Orzechowski *et al.*, “High Gain and High Extraction Efficiency from a Free Electron Laser Amplifier Operating in the Millimeter Wave Regime,” *Nuclear Instruments and Methods*, **A250**, 144-149, 1986.

⁵ D. C. Nguyen *et al.*, “Self-Amplified Spontaneous Emission Driven by a High-Brightness Electron Beam,” *Physical Review Letter*, **81**, pp. 810-813 (1998).

⁶ M. J. Hgan, C. Pellegrini, J. Rosenzweig, S. Anderson, P. Frigola, A. Tremaine, C. Fortgang, D. Nguyen, R. Sheffield, “Measurement of gain larger than 10^5 at 12 μm in a self-amplified spontaneous emission free-electron laser,” *Physical Review Letter*, **81**, pp. 4867-4870 (1998).

⁷ D. W. Feldman *et al.*, “High Extraction Efficiency Experiments with the Los Alamos Free-Electron Laser,” *Nuclear Instruments and Methods*, **A258**, 11, 1989.

⁸ D. C. Nguyen *et al.*, “First Lasing of the Regenerative Amplifier FEL,” *Nuclear Instruments and Methods*, **A429**, 125-130, 1999.

⁹ R. T. Nguyen, “Simulations of LANL Regenerative Amplifier FEL,” Master Thesis (William B. Colson, Thesis Adviser), Naval Postgraduate School, Monterey CA, 1997.

**APPENDIX F. GLOSSARY OF
ACRONYMS AND ABBREVIATIONS**

AAA	Anti-Aircraft Artillery
AAS	Affordability and Architecture Study
ABL	Airborne Laser
ACTD	Advanced Concept Technology Demonstration
ADA	Atmospheric Decision Aid
AFRL	Air Force Research Laboratory
ALL	Airborne Laser Laboratory
ATD	Advanced Technology Demonstration
ATGMS	Airborne Tactical Counter-Measures System
ATL	Airborne Tactical Laser
ATP	Acquisition, Tracking and Pointing
BCS	Beam Control System
BHP	Basic Hydrogen Peroxide
BMD	Ballistic Missile Defense
BMDO	Ballistic Missile Defense Organization
BMD SAS	Ballistic Missile Defense System Architecture Study
BVR	Beyond Visual Range
C3I	Command, Control, Communications and Intelligence
C4ISR	Command, Control, Communications, and Computers and Intelligence, Surveillance, and Reconnaissance
CA	Cloudy Arc
CAD	Computer-Aided Design
CFA	Cloud-Free Arc
CFLOS	Cloud-Free Line-of-Sight
Cl₂	Chlorine
COIL	Chemical Oxygen-Iodine Laser
CONOPS	Concepts of Operations
CONUS	Continental United States
CW	Continuous Wave
DARPA	Defense Advanced Research Projects Agency
DE-ATAC	Directed Energy Applications for Tactical Airborne Combat
DF	Deuterium Fluoride
DM	Deformable Mirror
EAADS	Extended Area Air Defense System
EAGLE	Evolutionary Aerospace Global Laser Engagement System
EC	Electro-Chemical
EC-COIL	Electrochemical Chemical Oxygen-Iodine Laser
EMD	Engineering and Manufacturing Development
EO	Electro Optical
FCS	Future Combat System
FEL	Free Electron Laser
FOC	Full Operational Capability
FRS	Fuel Regeneration System
FSM	Fast Steering Mirror

GBL	Ground Based Laser
GGG	Gadolinium Gallium Garnet
GPS	Global Positioning System
H₂O₂	Hydrogen Peroxide
HE	High Energy
HE-HMMWV	Hybrid Electric High Mobility Multi-Purpose Wheeled Vehicle
HEL	High-Energy Lasers
HELMP	High Energy Laser Master Plan
HELSTAR	High Energy Laser System-Tactical Army
HELSTF	High Energy Laser System Testing Facility
HF	Hydrogen Fluoride
HFOT	Hydrogen Fluoride Overtone
HMMWV	High Mobility Multi-Purpose Wheeled Vehicle
HP	High Power
HPM	High Power Microwave
HUD	Heads Up Display
IFX	Integrated Flight Experiment
IOC	Initial Operational Capability
IR	Infrared
IRCM	Infrared Counter-Measures
IRU	Inertial Reference Units
ISR	Intelligence, Surveillance and Reconnaissance
JCS	Joint Chiefs of Staff
JLab	Thomas Jefferson National Accelerator Facility
JROC	Joint Requirements Oversight Council
JTO	Joint Technology Office
KCl	Potassium Chloride
KEW	Kinetic Energy Weapon
KOH	Potassium Hydroxide
LASSOS	Lasers and Space Optical Systems
LiIon	Lithium Ion
LLNL	Lawrence Livermore National Laboratory
MNS	Mission Needs Statement
MTHL	Mobile THEL
Na	Sodium
NASA	National Aeronautics and Space Administration
NBC	Nuclear, Biological and Chemical
Nd	Neodymium
NMD	National Missile Defense
NRO	National Reconnaissance Office

O&O	Observe and Orient
ORD	Operational Requirements Document
OSD	Office of the Secretary of Defense
OWS	Outgoing Wavefront Sensor
PDRR	Program Definition and Risk Reduction
Pk	Probability of Kill
RCO	Rapid Cook-Off
RCS	Radar Cross Section
RF	Radio Frequency
RWS	Return Wave Sensor
S&T	Science and Technology
SB-COIL	Space-Based COIL
SBL	Space Based Laser
SBM	Space Based Mirrors
SBS	Simulated Brillouin Scattering
SDIO	Strategic Defense Initiative Office
SEAD	Suppression of Energy Air Defense
SMDC	[Army] Space and Missile Defense Command
SNS	Spallation Neutron Source
SOR	Starfire Optical Range
SRS	Simulated Raman Scattering
SSHCL	Solid State Heat Capacity Laser
SSL	Solid State Laser
STRS	Simulated Thermal Rayleigh Scattering
TAWG	Technology Area Working Group
TAWS	Target Acquisition Weather Software
TBM	Theater Ballistic Missile
THEL	Tactical High Energy Laser
TMD	Theater Missile Defense
TMS	Thermal Management System
TPDEW	Technology Integration Planning for Directed Energy Weapons
TRL	Technology Readiness Level
TTPs	Technology Transition Plans
UAV	Unmanned Ariel Vehicles
UCAV	Uninhabited Combat Air Vehicle
UHP	Ultra High Power
USD(AT&L)	Under Secretary of Defense for Acquisition, Technology & Logistics
USDOD-IMOD	United States Department of Defense-Israeli Ministry of Defense
UXO	Unexploded Ordnance
VHP	Very High Power

